

metos

TUNNEL DISHWASHER WD-11 *touch*



(translation of the original documentation)

Read the manual before using the machine!

Installation and user manual



1. General instructions	1
1.1 Symbols used	2
1.2 Machine rating	3
1.3 Checking that the machine and manual correspond	3
1.4 EU Declaration of Conformity	4
2. Safety instructions	5
2.1 General information	5
2.2 Transport	6
2.3 Installation	6
2.4 Detergent and drying agent	6
2.5 Operation	7
2.5.1 High temperatures	7
2.5.2 Risk of crushing	7
2.5.3 Risk of slipping	7
2.5.4 Sounds	7
2.6 Cleaning the machine	7
3. Installation instructions	8
3.1 General information	8
3.1.1 Rust on industrial dishwashers	9
3.2 Requirements for the installation site	10
3.2.1 Lighting	10
3.2.2 Ventilation and ambient temperature	10
3.2.3 Power supply	10
3.2.4 Water	10
3.2.5 Drain/waste pipe	10
3.2.6 Space for servicing	10
3.3 Transport and storage	11
3.3.1 Unpacking	11
3.4 Installation	12
3.4.1 Preparing for the installation	12
3.4.2 Positioning the machine	12
3.5 Connections	13
3.5.1 Electrical connection	14
3.5.2 Water connection, regardless of any options	14
3.5.3 Ventilation	14
3.5.4 Drain/waste pipe	15
3.5.5 Detergent and drying agent	15

3.6 Installation and connection of auxiliary equipment and options	20
3.6.1 Limit switch	20
3.6.2 Conveyors	20
3.6.3 Emergency stop	20
3.7 Trial operation	21
3.7.1 Start-up schedule	21
3.8 Documentation	22
4. Operating instructions	23
4.1 Before washing	24
4.1.1 Machine design	24
4.1.2 Preparations before filling	26
4.1.3 Touch panel	28
4.1.4 Filling and heating the machine	32
4.1.5 Positioning of dishware in baskets	34
4.2 Washing	36
4.2.1 Feeding loads into the machine	36
4.2.2 Washing with Automatic operation	37
4.2.3 Washing with manual operation	37
4.2.4 Cancelling washing	37
4.2.5 Emergency stop function	37
4.2.6 Guaranteed final rinse	38
4.2.7 Changing the water	38
4.2.8 Checking the wash result	39
4.3 After use – Cleaning	40
4.3.1 Incorrect cleaning methods	40
4.3.2 Emptying and daily cleaning	41
4.3.3 Cleaning and checking each week or as required	43
4.3.4 Operating problems	44
5. Technical specifications	50

1. General instructions

Read the instructions in this manual carefully as they contain important information regarding the correct, effective and safe installation, use and servicing of the machine. Service personnel should have access to all documentation for the machine.

Keep this manual in a safe place so that it can and should be used by other operators of the machine.



- The machine is intended to be used for washing dishware that is found in the general catering and restaurant trade. Other uses are NOT recommended!
- The machine can be equipped with a number of different options. Certain options may be standard in a number of countries. Check what your machine is equipped with.
- Use auxiliary equipment where possible to avoid heavy lifting.
- The machine's display indicates what the machine is doing. The machine's various temperatures and any alarms are also shown.
- The capacity requirements of the machine can be found in the TECHNICAL DATA chapter.
- The electronics in the machine are RoHS compatible.

Before the machine is started up and used, the following points should be observed:



- The SAFETY INSTRUCTIONS chapter must be studied carefully before commissioning the machine.
- Installation of the machine must be performed in accordance with the requirements and instructions indicated in the INSTALLATION INSTRUCTIONS and TECHNICAL SPECIFICATIONS chapters.
- Any personnel who may at some point use the machine must be trained in its operation, use and care.
- The machine should not be used by anyone suffering from a physical or mental illness.
- A close eye should be kept on any children in the vicinity of the machine to ensure they do not tamper with it.
- All cover plates must be fitted during use.



The machine and equipment requires an annual service. Contact one of our authorised and trained service companies for such a service.

1.1 Symbols used



This symbol warns of situations where a safety risk may arise. The instructions given should be followed in order to prevent injury and dangerous situations.



This symbol on a machine part warns of electrical equipment. The machine must be entirely non-live during servicing, turn off the power at the power switch and if required, the switch should be locked to prevent unintentional operation. The component may only be removed by a qualified electrician.



This symbol warns that the machine's electronics are sensitive to electrostatic discharge (ESD), which is why a static electricity wristband must be used when handling the electronics at all times.



This symbol explains the right way to perform a task in order to prevent poor results and/or damage to the machine.



This symbol identifies recommendations and hints to help you get the best results when washing, to increase the machine's lifespan and reduce the risk of emergency shutdown.



This symbol explains the importance of careful and regular cleaning of the machine to meet hygiene requirements.



This symbol warns of the importance to read the manual before using the machine.



This symbol warns that local regulations must be followed for recycling of packaging etc. as well as the destruction of the machine.



This symbol shows where any earth cable for potential equalisation can be connected. The earth bolt is placed on the machine's stand.

1.2 Machine rating

The machine has two rating plates, one of which is placed at the bottom of one side of the machine and the other in the electrical cabinet. The technical information on the plates is also included on the machine's wiring diagram. The various rating fields show:

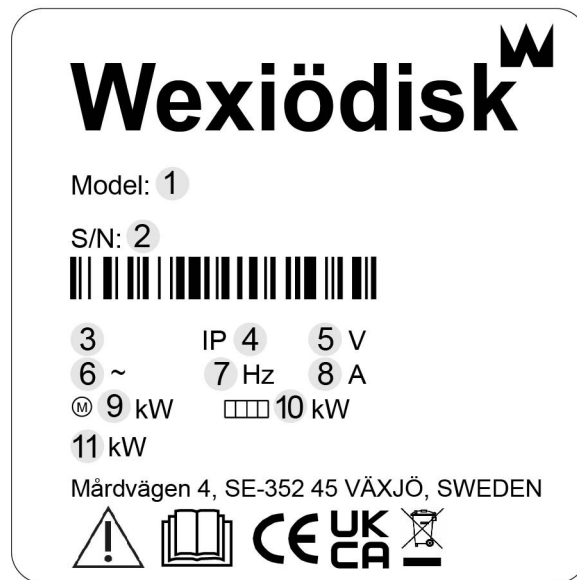

1. Machine type
2. Machine serial number
3. Year of manufacture
4. Enclosure protection class
5. Voltage
6. Number of phases with or without neutral
7. Frequency
8. Main fuse
9. Motor output
10. Electrical heating output
11. Max. output

1.3 Checking that the machine and manual correspond

Check that the type description on the rating plate corresponds with the type description on manual cover page. If manuals are missing, it is possible to order new ones from the manufacturer or the local distributor. When ordering new manuals, it is important to quote the machine number found on the rating plate.

1.4 EU Declaration of Conformity

A so-called EU Declaration of Conformity is provided on delivery of the machine.



CE DECLARATION OF CONFORMITY

This declaration of conformity only refers to the machine/product in the condition in which it is supplied, not any additions or modifications made by the customer/user.

1. Manufacturer: Wexiödisk AB Mårdvägen 4 S 352 45 Växjö, Sweden
 Tel: +46 (0)470 7712 00 Fax: +46 (0)470 237 52 E-mail: wexiodisk@wexiodisk.com

2. Representative: Böhraa General Trading, CMC Rydårg Group Ltd, DSE doo, Biskupova Servis d.o.o., Fastus ehf, KZB, Marlin Food Equipment Ltd, Moffat Pty Ltd, M/s Alshwarya Consolidates Pvt Ltd, Nakaniishi Mfg Co Ltd, QMB corporation, Retal doo, SRS Hygien i Kundtjän, TPN Group, Wexiödisk AB, Wexiödisk UK

3. Compiler of technical documentation: Magnus Ericsson

4. Our machines are manufactured **2016** in accordance with applicable EU directives and we declare under sole responsibility that the following products:

5. CE Declaration of Conformity, EU's Machinery Directive 2006/42/EG, annex IIIA, EU's Low-voltage directive 2006/95/EC, EU's EMC-directive 2014/30/EU, EU's WEEE directive 2002/96/CE, EU's RoHS-directive 2011/65/EU

6. Harmonised standards:
 EN 12100 Machine safety: General principles for design - Risk assessment and risk reduction
 EN 50108 Safety - Particular rules for corded tools
 EN 60228 Specification for degrees of protection provided by enclosures (IP code)
 EN 62233 Measurement methods for electromagnetic fields of household appliances and similar apparatus with regard to human exposure
 EN 61010-2-2 Electromagnetic compatibility (EMC) - Immunity standard for industrial environments
 EN 55014-1 Electromagnetic compatibility, Requirements for household appliances, electric tools and similar apparatus. (EMC) - Part 1: Emission
 EN 50181 Technical documentation for the assessment of electrical and electronic products with respect to the restriction of hazardous substances

7. The above directives and standards are common to the different machine groups. Standards in the tables below are specific to the different machine groups.

<p>7. Single tanks, Patented, Tunnel-dishwashers with accessories: WD-400 (1Y0001-1) WD-PR18007 & WD-70 & WD-70 & WD-70 (1Y20001-1) WD-42 (1Y0001-1) WD-PR18008 (1Y0001-1) WD-19 & WD-18-42 (2Y10-1) & WD-18-18-2HE & WD-18-18-423 (2Y00-1) & WD-24-17 & WD-37-17 (1Y2000-1) WD-PR18009 (1Y0001-1) WD-200 (1Y2000-1) WD-200C (1Y2000-1) WD-300 (1Y0001-1) WD-300C (1Y0001-1)</p>	<p>6. Harmonised standards to: EU's Machinery Directive 2006/42/EG, annex IA EN 0035-1 Safety of household and similar electrically operated machines EN 0035-2-30 Safety of the safety of household and similar electrically operated machines - Particular requirements - Commercial electric dishwashing machines</p>
<p>7. Conveyer, Special dishwashers: WD-3000 & WD-3001 & WD-3000R & ACS-3007 & WD-25BR & WD-3ET & WD-3020 & 3030: general assembly drawing WD-30WE (1Y00-1)</p>	<p>6. Harmonised standards to: EU's Machinery Directive 2006/42/EG, annex IA EN 0035-1 Machine safety: Technical aspects of machines, 3000 series of dishwashers</p>
<p>7. Special machines: ACS 4000C (0001) (1314-1)</p>	<p>6. Harmonised standards to: EU's Machinery Directive 2006/42/EG, annex IA EN 0035-1 Machine safety: Technical aspects of machines, 3000 series of dishwashers</p>

8. Växjö 2016-04-20

Magnus Ericsson
Managing Director

CE_16_2

1. Contact details of the manufacturer (Wexiödisk AB, Mårdvägen 4, SE-35245 Växjö, SWEDEN, Tel.: +46 470 771200, E-mail: wexiodisk@wexiodisk.com).
2. Representatives of Wexiödisk AB.
3. Person responsible for the product's documentation.
4. Year of manufacture of the product.
5. The EU Directives with applicable provisions to which all the machines, special machines and accessories comply.
6. Harmonised standards for the Directives specified, and which the machines, special machines and accessories meet, wherever relevant.
7. Model designation and serial number of the machines, special machines and accessories the document applies to.
8. Place and date with signature and name (in block letters) of the person responsible for ensuring compliance with legislation and regulations.

2. Safety instructions



Read the chapter GENERAL INSTRUCTIONS carefully before starting work.

2.1 General information



The machine is CE marked, which means that it complies with the requirements of the EU Machinery Directive with regard to product safety. Product safety means that the design of the machine will prevent personal injury or damage to property. The CE mark is only valid for an unmodified machine. Any damage to the machine arising from failure to follow the instructions will invalidate the supplier's warranty and product liability.



Installation, repairs and servicing must be performed by an authorised engineer in accordance with local and national rules in effect for such work with water and drainage systems, electricity, ventilation and steam. To ensure electrical safety, components must only be tested when fitted in their normal place in the machine. We recommend that the work is performed by the manufacturer or one of the manufacturer's authorised service companies.

To further improve safety during installation, operation and servicing, the operator and the personnel responsible for installing and servicing the machine should read the safety instructions carefully.



The machine's electronics are sensitive to electrostatic discharge (ESD), which is why a static electricity wristband must be used when handling the electronics at all times.

Before the machine enters service, ensure that the personnel are given the necessary training in handling and looking after the machine.

In order to avoid dangerous situations, the following must be followed:



- Switch off the machine immediately in the event of failure or malfunction.
- Make sure the machine is non-live before removing the cover plate. Turn off the power using the power switch. If required, the switch must be locked to prevent unintentional operation.
- Shut off the tap for incoming water and drain the machine's tank(s) before starting work. Let the machine cool down as pipes for water, washing pumps, booster heaters and valves become very hot when the machine is in operation.
- The machine and equipment requires an annual service. The machine should be serviced by a person authorised or trained to do so by us. Use original spare parts.
- Warranty repairs must be performed by an authorised company. Contact an authorised service company to draw up a programme of preventive care and maintenance. For authorised service companies, please see www.wexiodisk.com or contact Wexiödisk AB.
- The regular checks described in the manual must be carried out in accordance with the instructions.

2.2 Transport



Handle the machine with care during unloading and transport; there is a risk of it tipping over. Never lift or move the machine without using the wooden packaging to support the stand.

2.3 Installation



- The machine is designed for quick electrical installation.
- The machine must be connected to a lockable power switch.
- Make sure that the mains voltage is the same as that indicated on the machine's rating plate.



For increased safety, it is recommended to equip the installation with a ground fault circuit breaker.

2.4 Detergent and drying agent



Be aware of the risks involved in handling detergents and drying agents. Protective gloves and safety glasses should be used when handling, and an eyebath should be within easy access. Read the warning text on the detergent and drying agent containers as well as the detergent supplier's instructions.

2.5 Operation



Be very careful around the machine when it is in operation.

2.5.1 High temperatures



- The temperature of the washing and rinsing water is 60°C and 85°C. Do not open the machine until the washing and rinsing phases have finished. The steam that comes out of the machine after the wash has been completed is hot.
- Avoid touching hot pipes and booster heaters. The machine's outer jacket can also become hot during operation.

2.5.2 Risk of crushing



The machine, and any equipment, has moving parts before, during and after washing. Be careful therefore to avoid crush injuries. In connection with service or repairs that require the doors to be open, these must be secured by means of a prop for example.

2.5.3 Risk of slipping



The floor should be kept clean and dry to eliminate any risk of slipping. Mop up any water and leftover food that has been spilt.

2.5.4 Sounds



The machine is not silent during operation, see TECHNICAL SPECIFICATIONS. Hearing protection may therefore need to be used.

2.6 Cleaning the machine



The water in the tank has a temperature of approximately 60°C and contains detergent. Be careful when draining and cleaning the wash tank. Wear protective gloves and safety glasses and have an eyebath within easy access.

3. Installation instructions



Read the chapters GENERAL INSTRUCTIONS and SAFETY INSTRUCTIONS carefully before starting work.

3.1 General information



Read these instructions carefully, as they contain important information regarding the correct installation method.

- The instructions should be used together with the machine's wiring diagram and flow diagram. These can be found behind the cover plate for the chemical wash zone.
- The machine can be equipped with a number of different options. Certain options may be standard in a number of countries. Check what your machine is equipped with.
- If holes need to be drilled in the machine, the holes must be fitted with an edge strip or similar protection.

3.1.1 Rust on industrial dishwashers



- Large-scale industrial dishwashers in general as well as our dishwashers are made of stainless materials, but despite this, there are still situations where rust can occur on “stainless” materials.
- We are going to describe a few reasons for this here, so that you, as a user, service engineer or other type of personnel, can avoid this.
- Rust usually occurs due to the fact that something that is not stainless finds its way onto the stainless surface. The non-stainless particles will soon start to rust, and then contaminate the stainless material, which also starts to rust. If no action is taken at this point, serious damage such as a hole in the material can occur.

RISK SITUATION	CAUSE	DECLARATION / ACTION
Drilling holes when installing a detergent device.	Using a drill or hole saw that has previously been used for ordinary non-stainless materials.	“Contaminated” hole-drilling tools can cause enormous damage in the form of pores in stainless plates. Never use a cutting tool that has previously been used on other materials or blackplate.
	Using blunt tools when drilling holes.	Stainless plate, which has overheated during hole drilling, may lose its “stainless” properties. This can show up as rust around the hole for the detergent cell.
	Shavings from hole drilling.	The shavings from drilling or hole sawing are usually heated so much that they lose their stainless properties. They must always be removed by hand! Washing after hole drilling is not enough!
Rust spots that occur during normal operation and use.	Minerals, e.g. ferrous gravel or earth, from dishware or food (vegetables and root vegetables) that has been lying in crates, find their way onto the stainless surface. Minerals (gravel) can also be found on the wheels of catering trolleys.	Daily cleaning is always important. Use a suitable brush for “mechanical” cleaning, e.g. in the wash tanks, on the wash trays and filters.
	Steel wool. Ordinary steel wool is not stainless, and can cause serious damage to stainless surfaces and plates.	Use stainless cleaning pads. Remove all ordinary steel wool from the catering facility / restaurant.

N.B.! If rust spots have developed, they must be dealt with immediately by a person authorised to do so!

3.2 Requirements for the installation site

3.2.1 Lighting

In order to ensure the best possible working conditions during installation, operation, servicing and maintenance, make sure that the machine is installed in a well-lit room.

3.2.2 Ventilation and ambient temperature

The machine is intended to be used in an indoor environment at normal room temperature. The machine produces heat and steam when in operation. In order to ensure the best possible working conditions, a certain air renewal rate is required in the dishwashing room. The ventilation requirements for the dishwashing room are to be dimensioned on the basis of the applicable standards.

3.2.3 Power supply

Power supply connections are made by qualified personnel in a way that complies with local and national regulations. The machine's capacity requirements are stipulated in TECHNICAL SPECIFICATIONS.

3.2.4 Water

Water connections are made by qualified personnel in a way that complies with local and national regulations. The machine's capacity requirements are stipulated in TECHNICAL SPECIFICATIONS.

3.2.5 Drain/waste pipe

There must be a waste pipe with an effective trap for the machine's waste water and for water used for rinse cleaning. The machine's capacity requirements for drainage are stipulated in TECHNICAL SPECIFICATIONS.

3.2.6 Space for servicing

A 1-metre area should be left clear in front of the machine for servicing purposes. Depending on if the machine has different accessories, there may also be such a requirement at the infeed and outfeed ends as well as above the machine.

3.3 Transport and storage

Always transport the machine in an upright position.



Take care during transport, as there is a risk of tipping. N.B.! The machine must not be transported without a pallet or other support. Some form of support beam must always be used along the sides of the machine during transport. Otherwise the machine may become damaged. When transporting the machine without a normal wooden pallet, always check that none of the components underneath the machine can be damaged.

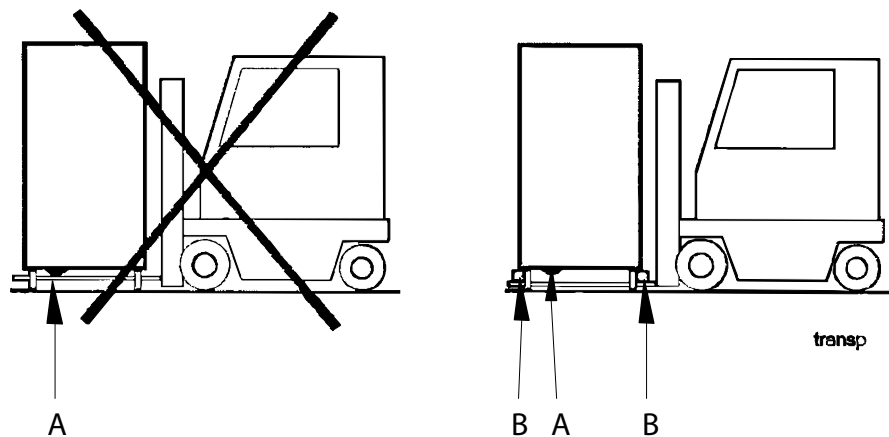

A=Pumps
B=Spacers



If the machine is not being installed immediately, it must be stored in a frost-free area where the air is dry.

3.3.1 Unpacking

Check that all parts have been delivered by comparing them with the delivery note.

Remove the packing material. Inspect the machine for any transport damage.

Recycling



- The machine is manufactured from stainless steel plate, among other things, and also contains electronic components. Recycling of the appliance when its economic lifetime has been reached must be carried out in accordance with current rules and regulations.
- Packaging must be sent for destruction or recycling in accordance with local regulations.

3.4 Installation

3.4.1 Preparing for the installation

Check that there is sufficient room for the machine at the installation location.



- Check that correct connections are available for water, electricity, drainage and possibly steam at the installation location. See TECHNICAL SPECIFICATIONS.
- Check that the overheating protection device is reset.

3.4.2 Positioning the machine

Check the following points before the machine is placed in position:



- Check that the fuse for the machine at the site is off, blocked and that outgoing electrical circuits from the machine are non-live.
- Remove the protective plastic on the sides which are to be stood against a wall.
- The distance between the wall and machine should be at least 30 mm.

Place the machine in position and check that it, and any accessories, are horizontally level. Place the spirit level on the join between the machine tank and the upper part. Adjust the height with the legs.

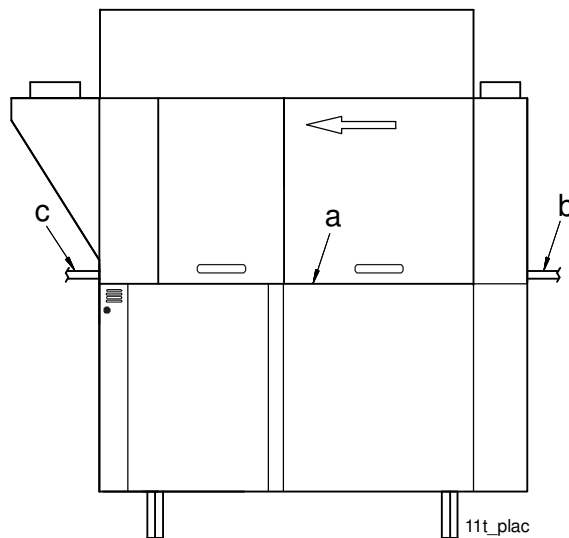

The machine must be evenly balanced on three sides:

- On the cover edge of the front side (a) (tank body).
- On the cover of the infeed (b).
- On the cover of the outfeed (c).

Once the machine has been filled with water, do another check to make sure the machine is horizontal.

3.5 Connections

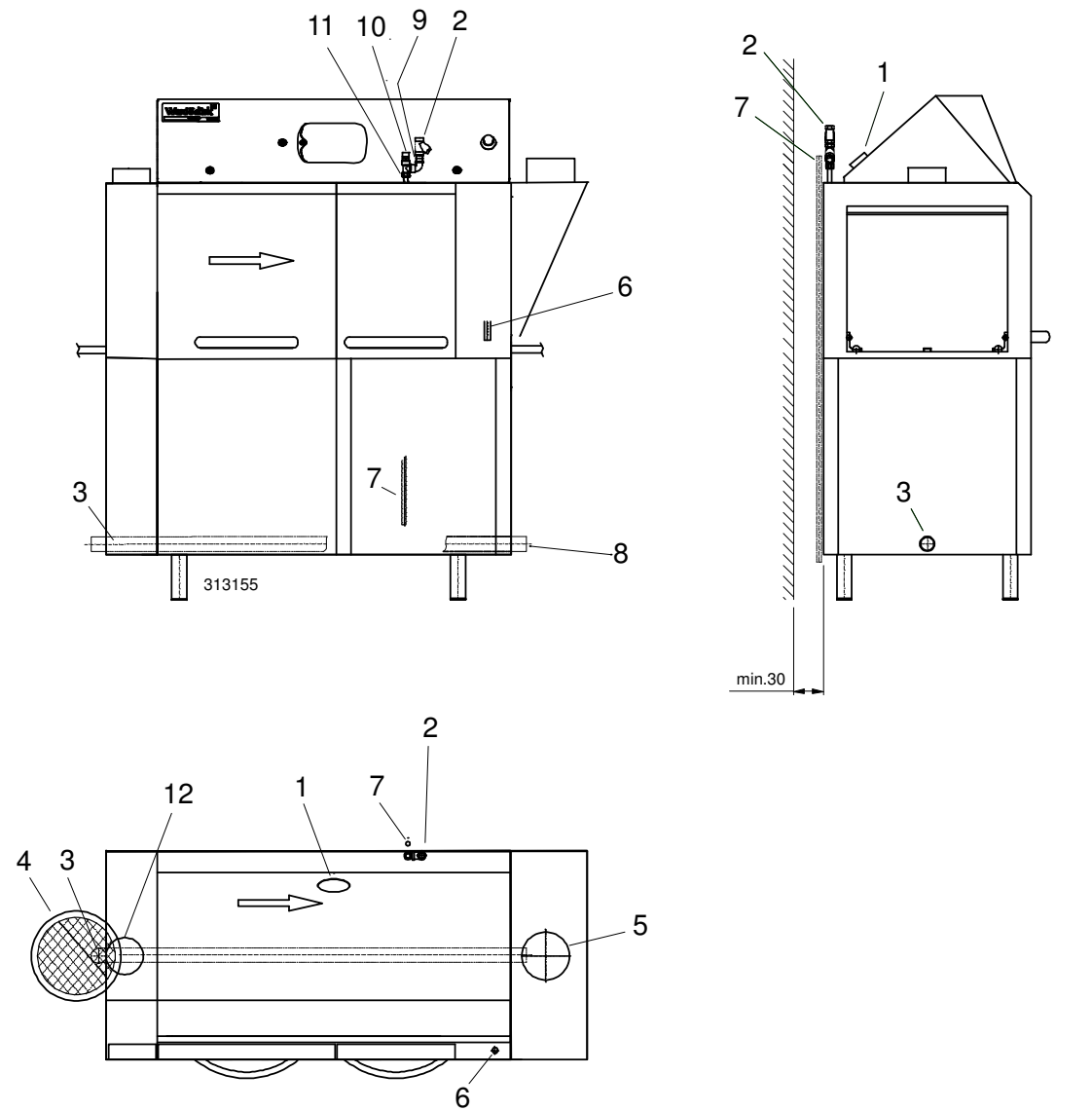

1. Electrical connection
2. Hot water connection, (cold water connection (option))
3. Drain/waste pipe connection
4. Floor drain
5. Ventilation connection, outfeed
6. Alternative electrical connection
7. Alternative hot water connection, (cold water connection (option))
8. Alternative drain connection
9. Non-return valve
10. Vacuum valve
11. Detergent dosage outlet
12. Ventilation connection, infeed

3.5.1 Electrical connection

Information about electrical connections is available on the machine's wiring diagram which is provided on delivery. Store these in the special plastic document wallet.



- The machine is designed for quick electrical installation.
- The machine must be connected to a lockable power switch. This should be placed on a wall, well-protected from water and from the steam which escapes when the machine is opened.
- Connect the cable at (1), or alternatively the machine may have an electrical connection from the floor (6). Protect the incoming cable with, e.g. Pipe for connection cable, WD212.4102 (option).
- Check the direction of rotation of the pump motors during operation when the tanks are full of water. The direction of rotation must conform without exception to the direction of the arrow on the pump. Stop the dishwasher immediately if the direction of rotation is incorrect and change two of the incoming phases.

After completing the installation, switch on the power switch and all circuit breakers.

3.5.2 Water connection, regardless of any options



- A shut-off cock must be installed on the incoming pipe.
- It is important that the water supply has sufficient pressure to ensure the correct flow of water to the machine. The required water flow and pressure can be found in the TECHNICAL SPECIFICATIONS. If the water pressure is too low, a booster pump must be fitted.

The water pipe is connected at (2), or alternatively at (7). If the machine is connected with a hose, this should be steel braided and have an internal diameter of at least 12 mm.

The water connection on the machine is fitted with a filter, non-return valve and vacuum valve.

As the machine is fitted with a "break tank", the connection is fitted with a filter and non-return valve.

3.5.3 Ventilation

The machine's heat load for the room is stipulated in TECHNICAL SPECIFICATIONS.

Connection to the ventilation duct is done at the outfeed (5) and the infeed (12).

If a hood is fitted over the machine, it must cover the drying rack after the machine.

3.5.4 Drain/waste pipe

The waste water system connected to (3 or 8) should consist of a 50mm metal pipe that will withstand mechanical impacts. The waste pipe must run to a floor drain, where its opening must be above the water level.

The drain can be fitted to the right or left. Remove the perforated section of the end plate and pull the pipe through the hole. Connect the drain and run to the floor drain where it should flow freely above the water level.

Ensure that the drain connection is kept in place by using e.g. cable ties in the designated areas.

3.5.5 Detergent and drying agent



- Check what your machine is equipped with, which depends on the model, machine type and country.
- Use the same make and type of detergent and drying agent.
- With machines connected to cold water, the water pipe temperature may be too low for use of powder or paste type detergents.
- If liquid detergent is used together with Wexiödisk's detergent pump, the detergent must be placed under the machine's tank level.

If equipment for a different type of detergent is used, it should preferably be put on the wall behind the machine to avoid holes being drilled unnecessarily in the machine.

The process of setting the detergent and drying agent dispenser is described in the ADJUSTMENT INSTRUCTIONS.

For information about wiring diagram, see the machine's wiring diagram.

Connection of the equipment

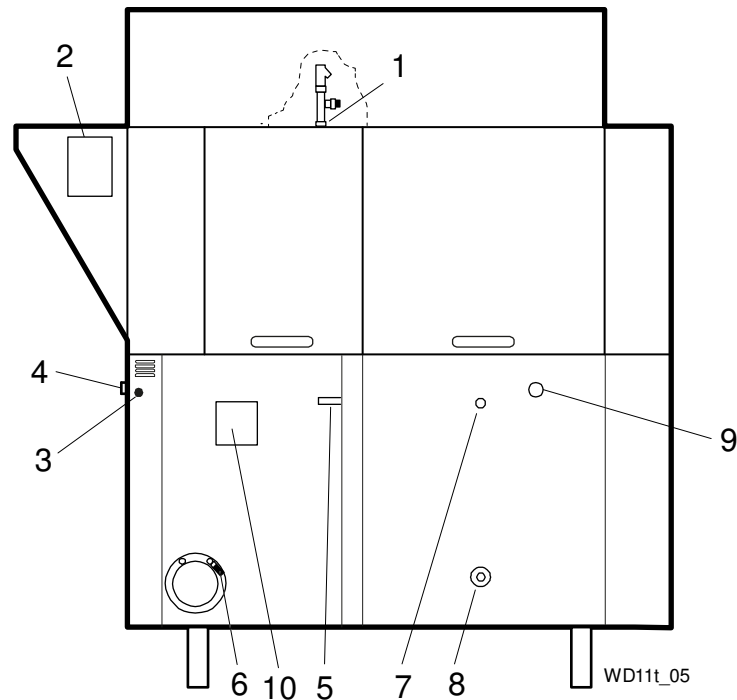

1. Hot water outlet
2. Alternative location of detergent equipment
3. Hole \varnothing 25 mm for hose intended for detergent in solid form
4. Hole \varnothing 19 mm for drying agent hose
5. Plugged connection \varnothing 18 mm for connecting hose for detergent in solid form
6. Drying agent dosage outlet
7. Plugged connection in the chemical wash tank \varnothing 11 mm for liquid detergent
8. Plugged connection for measuring cell for measuring the detergent concentration in the chemical wash tank. The measuring cell is connected in the junction box (10).
9. "DETERGENT" adhesive label. The label is affixed to the inside rear wall of the chemical wash tank and indicates the alternative position of the detergent opening. Drill a hole from the back of the chemical tank through the plugged hole in the rear cover plate.
10. Junction box with connections for detergent and drying agent.

Electrical connection of the equipment

The electrical connection for the detergent and drying agent is in the junction box (10).

To avoid making unnecessary holes in the machine, the equipment should be placed on the wall behind the machine on the outfeed side.

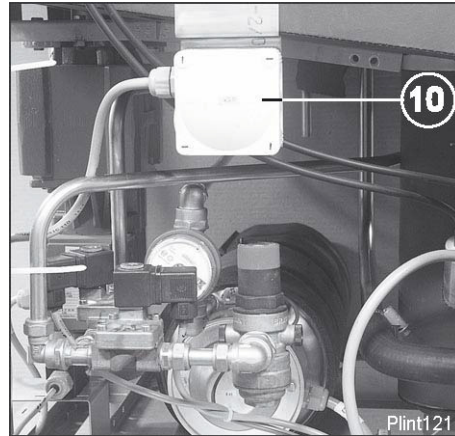

Connections for detergent and drying agent. N.B.! 230V

Detergent dosage

The water outlet (1) for the detergent dosage is placed on the incoming hot water pipe.

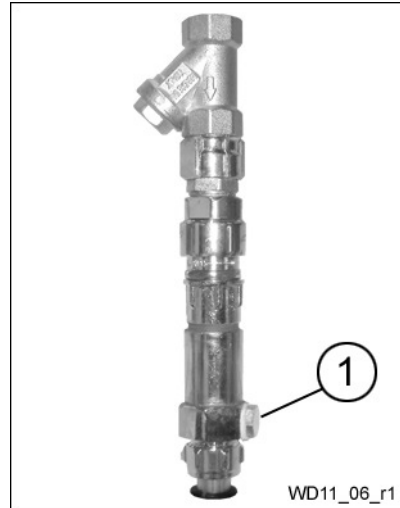

Hot water outlet

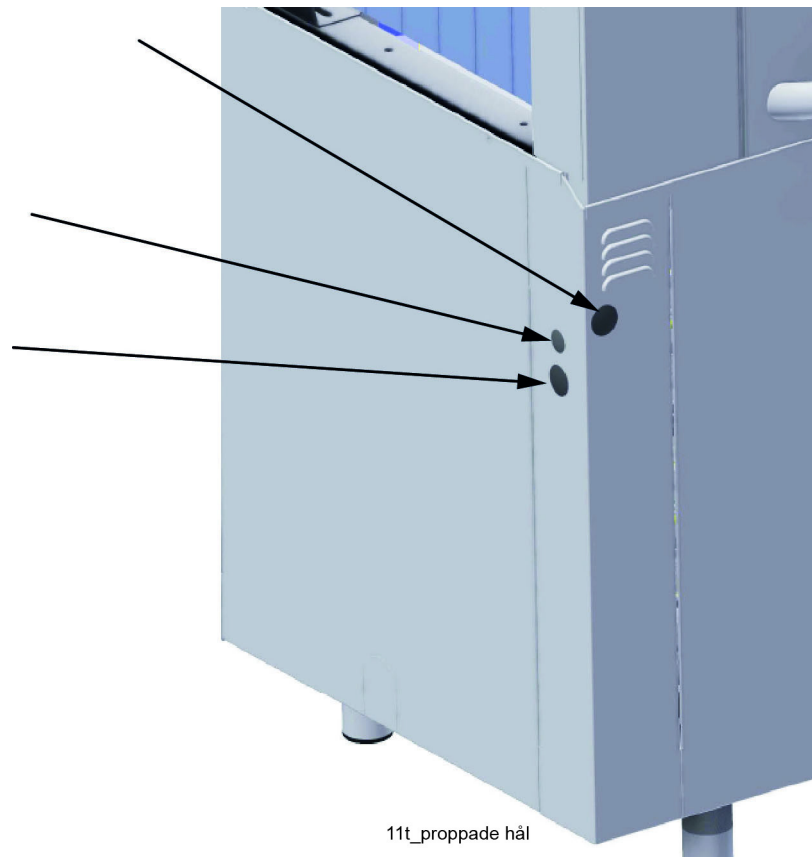

Plugged holes for hoses for detergent and drying agent

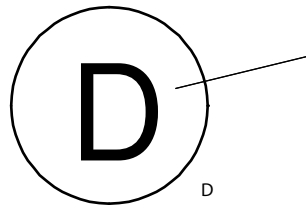

"D" indicating alternative opening for detergent

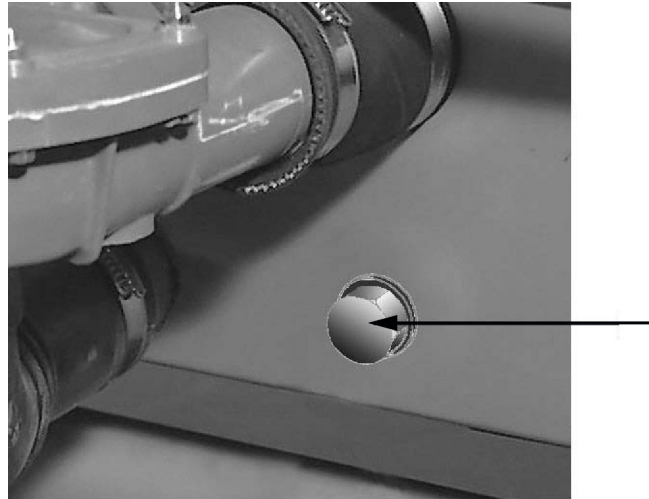

Plugg_R2

Plugged hole for measuring cell

Drying agent dosage

The connection for drying agent (6) is located next to the booster heaters.

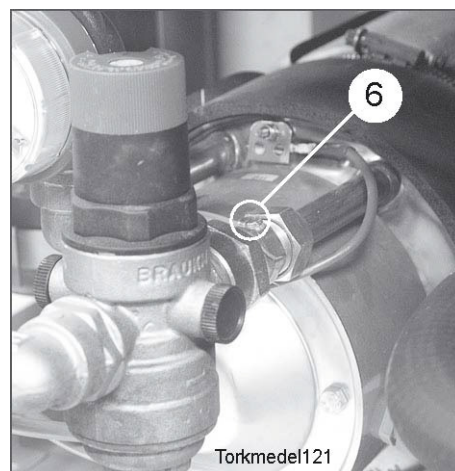

Drying agent dosage outlet

3.6 Installation and connection of auxiliary equipment and options



- Once the machine is in place and has been adjusted horizontally and vertically, the auxiliary equipment can be fitted.
- The machine can be equipped with a number of options. Check what your machine is equipped with, which depends on the model, machine type and country.

The various options normally place no specific requirement on the installation.

3.6.1 Limit switch

Connection of the limit switch is done on connection X10 in the electrical cabinet. When connecting, remove the existing clamp on the connection points. See the machine's wiring diagram. The limit switch is designated S11 in the wiring diagram. N.B.! The machine's voltage is 24V.

3.6.2 Conveyors

Installation of in- and outfeed equipment (conveyors, curves) must be performed in accordance with the wiring diagram's main circuit instructions. This applies to machines equipped with a motor switch and contactors for this equipment.

Connection of supply voltage to the in- and outfeed equipment is performed in accordance with the wiring diagram's instructions. N.B.! The machine's voltage is 24V.



When fitting a motor switch and contactors retrospectively, use the components on the wiring diagram and follow the connection instructions. This affects the manufacturer's liability. See "SAFETY INSTRUCTIONS".

3.6.3 Emergency stop

Connection of further emergency stops is done to connector X10 in the electrical cabinet. Replace the existing clamp on the connection points when connecting a new emergency stop. See the machine's wiring diagram. The extra emergency switch is designated S2 in the wiring diagram. N.B.! The machine's voltage is 24V.

3.7 Trial operation

Prepare the machine for trial operation with the help of OPERATING INSTRUCTIONS. The instructions describe the measures that must be taken to prepare the machine for operation.

3.7.1 Start-up schedule

This should be completed when the machine is started up and used.

Machine type:
Machine serial number:
Installation date:

Read the installation and user manuals carefully. Then check the following points:

1. Check:

- Water and waste pipe connections
- That the machine is evenly balanced
- That the closed doors are in line
- That the benches, conveyor bend etc. are correctly fitted
- Detergent and drying agent
- That the filters, level pipe, outlet seal, filter tray and curtains are in position
- The mini-switches for all the heating elements must be in the OFF position.
- That the overheating protection device is reset

2. Filling the machine:

- Close the doors
- Switch on the power switch and press 0/1
- Fill the machine with water in accordance with the OPERATING INSTRUCTIONS

Note: It takes between 5 and 30 minutes to fill the system. The booster heaters fill automatically when the doors are closed. The machine has a filling check function for the booster heaters. When the function is activated, a check is carried out to ensure that the booster heaters are full of water, before the element is switched on.

Note: If the filling process is interrupted using the main switch, the check starts again from the beginning.

- When the filling check has been completed and all the tanks are full, the mini-switches for the booster heaters switch on.

3. Check the setting of the reference values:

- All the reference values have been set to the recommended values on delivery
- Check that the motor cut-off switch for the infeed and outfeed conveyors have been set correctly

4. Start the machine:

- Check the direction of rotation of the pumps
NB! If the direction of rotation is wrong, the phase must be inverted on the incoming feed.
- Check that the overload switch on the feed cradle is functioning.

5. Lock the impulse arm and the photocell in the activated position:

- Run the machine continuously for 10 minutes. Check and adjust the temperature and water flow
- Final rinse (around 7 litres/minute)
- Reset the impulse arm and the photocell to the initial position.

6. Run a number of washes complete with dishware and check:

- The basket is in the correct position after the photocell
- There are no water leaks
- The door switch works
- The limit switch is working
- Steam discharge from the machine
- The water temperatures are maintained
- The dishware is clean
N.B.: If the machine is equipped with detergent dosing, this function is roughly set at the factory; contact your chemical supplier for a more precise setting.
- The dishware is dry
N.B.: If the machine is equipped with drying agent dosing, this function is roughly set at the factory; contact your chemical supplier for a more precise setting.

7. Final check: Empty the machine, turn the machine off using the ON/OFF button and then turn off the power at the power switch:

- Re-tighten all the connections on the circuit breakers and contactors
- Check that all the mini-switches and the motor cut-off switch are in the on position.
- Display the quick guides supplied with the machine

8. Train and inform personnel concerning:

- Washing
- Care (daily, weekly and other frequencies)
- Recommendation for annual service

3.8 Documentation



For correct use and servicing, it is essential that the documentation accompanying the machine is made available to personnel who will be using the machine. The installation and user manual, which describes handling and care among other things, should be stored near the machine.

4. Operating instructions



Read the chapters GENERAL INSTRUCTIONS and SAFETY INSTRUCTIONS carefully before starting work.



- The machine's touch panel contains built-in guides on what and how things must be done.
- The use of the machine is dependent on how the machine is equipped.



This chapter describes what must be done with the machine:

- Before washing
- How washing should be performed
- After completed washing
- In the event of error messages and troubleshooting



If the machine will not be used for a longer period, the power to the machine should be turned off using the power switch, the water supply turned off and machine should be left open.

4.1 Before washing

4.1.1 Machine design

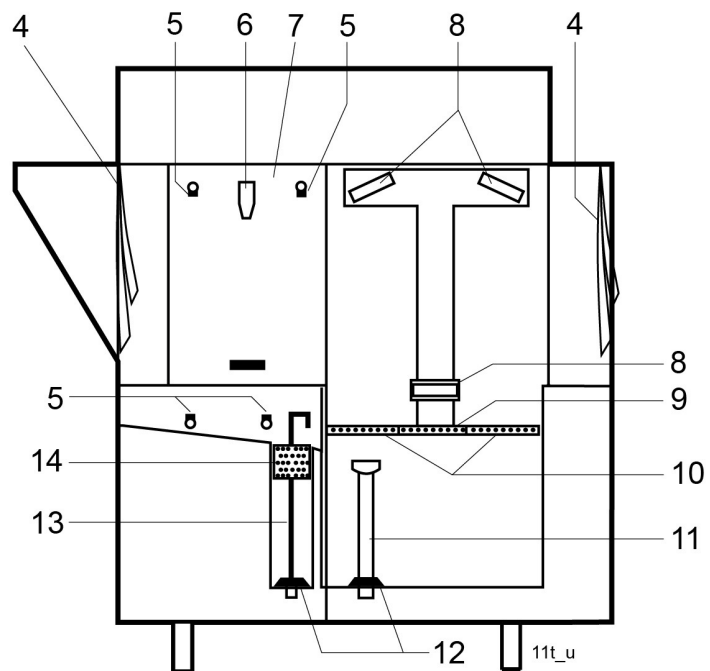

1. Touch panel
2. ON/OFF button
3. Emergency stop
4. Curtains
5. Wash nozzle
6. Catch
7. Door
8. Wash arms
9. Plate between filter tray
10. Filter
11. Level pipe
12. Rubber sleeve
13. Outlet seal
14. Filter for the final rinse
15. Timer for a timed start of the machine (option)

In the following chapter, figures are given in brackets to clarify what needs to be done. These numbers refer to image and list above.

4.1.2 Preparations before filling

Check:



- That the machine and removable parts have been cleaned. If not – clean them!
- That there is no dirt in the wash arms (8) or rinse nozzles (5).
- That removable parts are correctly in place
- The amount of detergent and drying agent.
- That the stopcock for the water to the machine is open.
- That the power switch is switched on.

Remember:



- Ordinary washing-up liquid must not be used in the machine or for soaking. Contact your detergent supplier regarding the choice of a suitable detergent. Washing-up liquid causes a build-up of foam, produces poor wash results and can damage the machine.
- Steel wool must not be used for pre-treating the dishware.
- Only detergent and drying agent intended for industrial machines may be used.
- Use the same make and type of detergent and drying agent.

Curtain placement



The curtains in the machine must hang in accordance the image depending on the feed direction.

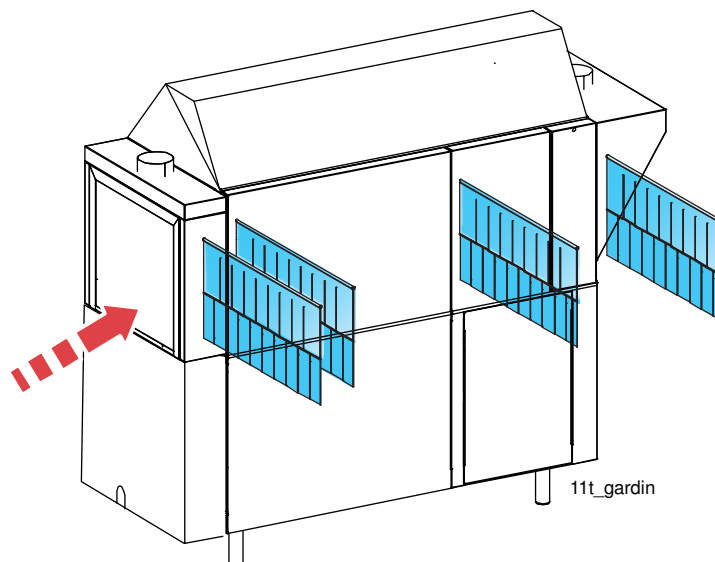
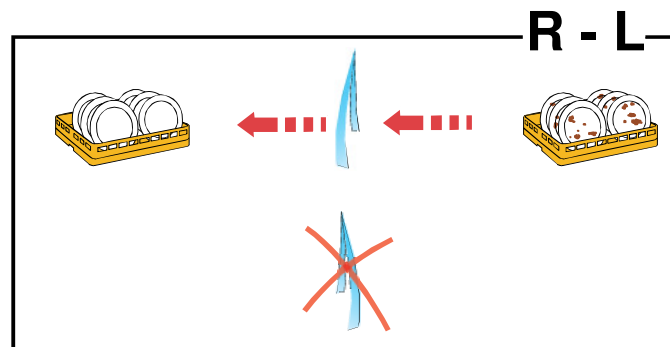
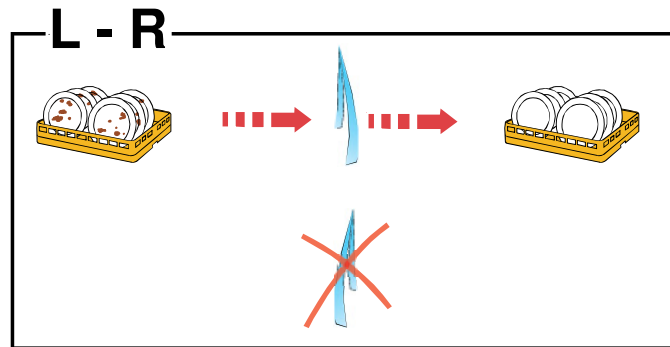

The machine in the image has a left - right feed direction

4.1.3 Touch panel

General

The panel comprises four fields:

- A = Top bar
- B = Process bar
- C = Activity field
- D = Bottom bar

Active (clickable) symbols are in blue. Inactive symbols are in grey. The activity field (C) contains both information text and selectable symbols which are used to continue to different entries:

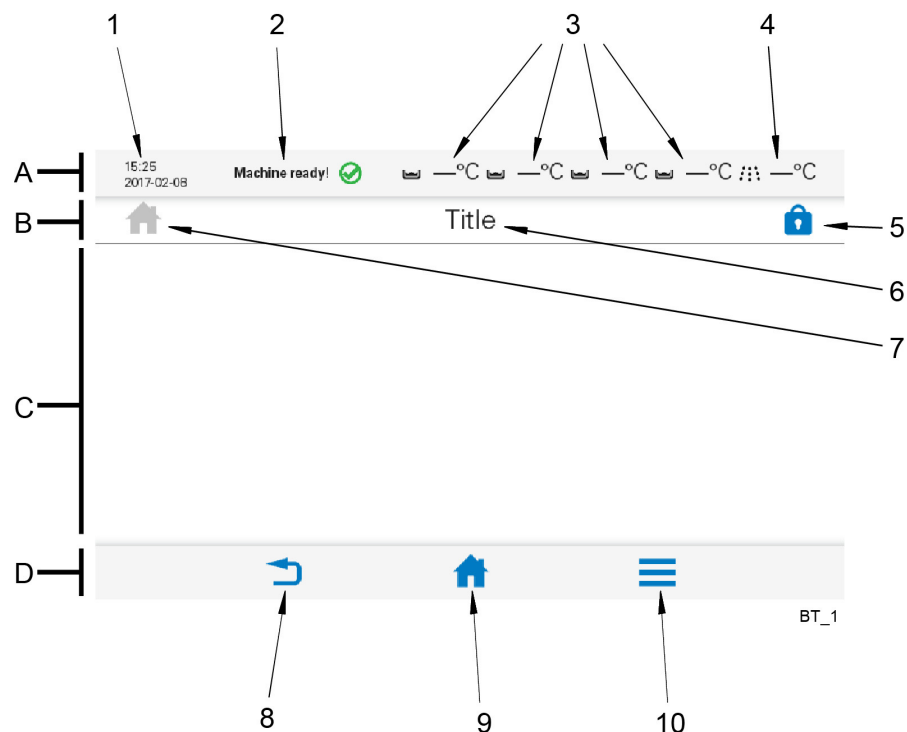

The various fields are divided into the following parts:

1. Date and time
2. Machine status
3. Temperature of tanks
4. Temperature of final rinse
5. Login symbol
6. Text describing what happens in the activity field
7. Symbol for function displayed
8. Back button
9. Home button
10. Menu button

Top bar (A)

This indicates the machine status using text and symbols (2, 3, 4) and the date and time (1).

Alarm and information messages are displayed here. More information about these is shown in the activity field (C).

Process bar (B)

This indicates what the machine is doing using various symbols (7) and text (6). This is where authorised personnel log in (5).

Activity field (C)

This indicates what must be done or what is happening in the machine, and is shown using various figures and text.

Alarm and information messages are displayed in detail here. There are three different levels of these.



- BLUE: Information message with code number.
- YELLOW: Non-critical alarm message with code number. Yellow alarms may be reset by the user. A yellow alarm may change to a red alarm after being displayed a certain number of times.
- RED: Critical alarm message with code number. Service personnel must be contacted for these alarms.

Bottom bar (D)

This displays the machine's three main symbols (8, 9, 10).



Back button (8)



Home button (9)



























Menu button (10)

Symbols

The following symbols and a brief description may be displayed in the various fields of the panel (some depending on machine type).

Symbol	Explanation	Symbol	Explanation
	Black: Information Blue: About the machine		Change the water
	Autostart of filling and washing		Consumption
	Back to previous figure / Reduce	ECO	Environmentally friendly/ Lowest consumption
	Cleaning the machine		Consumption costs
	Contact details		Warning / Alarm for operator
	Cost		Detergent
	Cancel / Reset		Down / Reduce
	Remove / Clear		Yes / Confirm / Ready
	Diagnosis		Fill tank
	Drying		Forward to next figure / Increase
	Edit		Strong/ Highest consumption
	Empty tank	HACCP	HACCP
	Final rinse		Medium / Normal consumption
	Home		Journal
	Language		Log
	Logged in		Logged out

Symbol	Explanation	Symbol	Explanation
	Low flow		Machine status
	No / Cancel		No flow
	Other		Wash program for mixed dishware
	Manual feeding		Empty the machine
	START / ON		Protocol
	Glass		Plates
	Pots		Relay test
	Repeat / Machine is in operation		Reset
	Save to PC		Save to USB
	Service alarm		Service settings
	Machine configuration		Settings
	Updating software		Time and date
	Statistics		STOP / OFF
	Tank		Temperature / Heating
	User		Up / Increase
	Filling tank		View service settings
	Return / Back		Menu

4.1.4 Filling and heating the machine

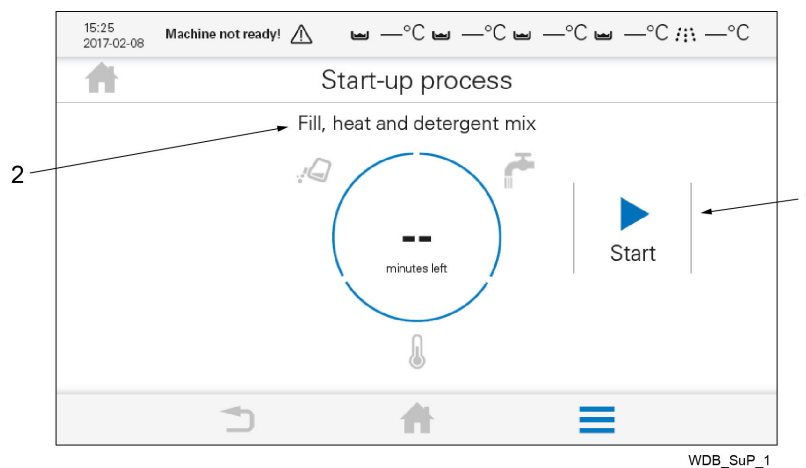
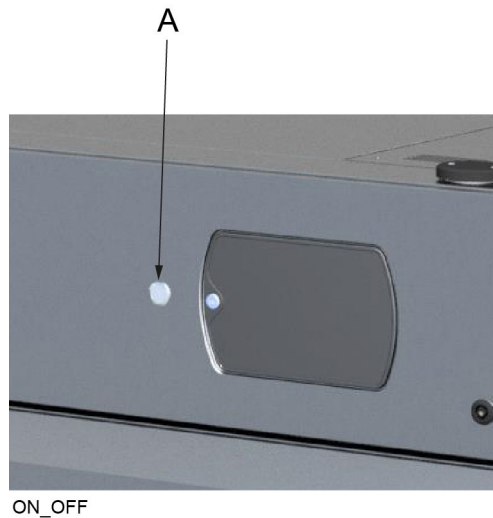

- A: ON/OFF button
- 1. Start button
- 2. Activity text
- Press the ON/OFF button (A) located in the vicinity of the touch panel to start the machine. N.B.! At least 25 seconds must have elapsed after the main switch is set in the ON position. The touch panel will illuminate after approximately 10 seconds.
- Press the start button (1) in the activity field to start filling and heating. It is possible to follow what is happening in the machine via the touch panel.
- The machine has an Autostart function, where a date and time can be entered for the automatic filling and heating of the machine. The function is located under Autostart in the main menu and only works if all level pipes have been set and all the doors are closed.



N.B.! The time it takes for the machine to fill and heat up to the right washing temperature varies between 5 and 30 minutes and depends on the temperature of the incoming water.

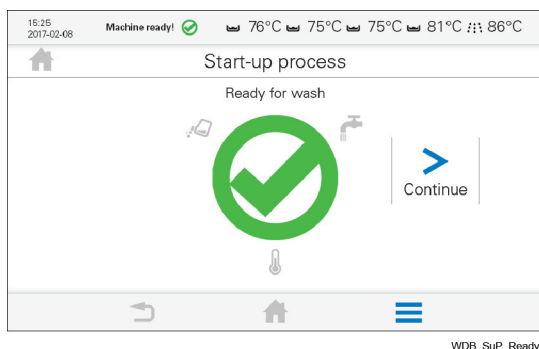

The figure above will be displayed when the machine is ready for washing.

4.1.5 Positioning of dishware in baskets



The machine is supplied with washing baskets depending on the equipment level. The washing baskets are used according to the following:

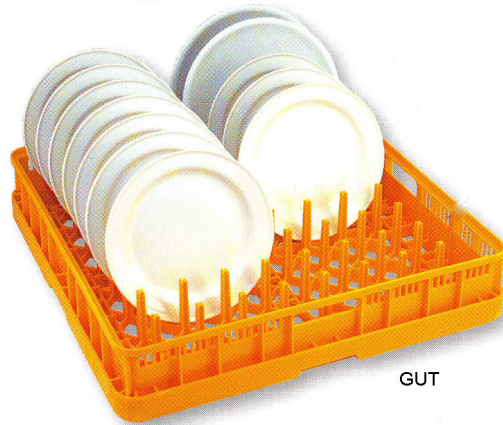

The yellow basket is used for side plates, trays, plates, etc.



The blue basket is used for glasses, cups and canteens



The brown basket is used for cutlery during the first wash

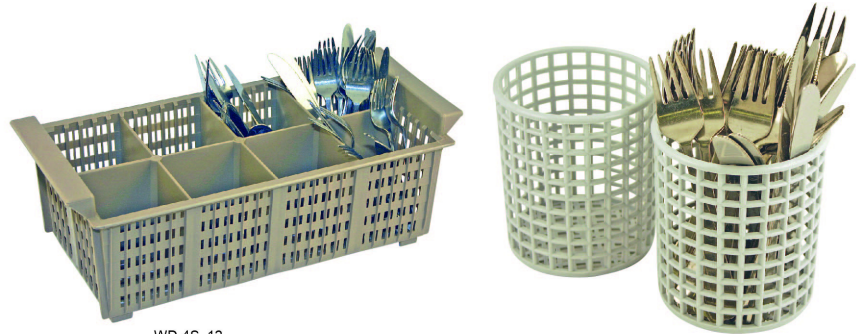

WD-4S_12

Cutlery must therefore be placed in designated baskets before the second wash, the baskets above are placed in the blue basket

4.2 Washing



DIN 10510 is a German standard which describes how the washing process must work in a tunnel dishwasher in order to ensure good washing results. Amongst other things, it recommends that the contact time should be around 120 seconds for normally soiled loads. The contact time is the time which the load spends in a wash or rinse zone with washing water containing detergent. In principle this means the period from when the load enters the pre-wash zone to when it is rinsed with clean water in the final rinse zone. The standard is a useful means of comparing the capacity and consumption of different dishwashers.

Proceed as follows:

- When washing is to start, the dishwasher must be prepared, i.e. the washing tanks must be filled and the water in them heated.
- Scrape off food residues. Items with dried-on food residue may need to soak.
- Put the dishware in baskets. Plates and trays must be placed longitudinally in the machine.
- Choose between Automatic and Manual operation on the touch panel in the activity field.
- The most recently selected operating method will be saved for the next time the machine is turned on.
- Check the wash result when the item is removed from the baskets.
- In the event of a fault on the dishwasher during operation (machine fault or human error), an alarm will be shown in the display on the dishwasher's touch panel. Certain machines can be equipped with lights to indicate whether any alarms are active in the dishwasher.
- Before washing starts, you should make sure that you know where the dishwasher's emergency stop is located.



4.2.1 Feeding loads into the machine



- Once the feed device begins to pull the basket into the machine, the basket must not be pushed manually. This may disturb the wash cycle, resulting in impaired wash results.
- Feed in the baskets at approx. 35 cm intervals. Increase the distance if the items to be washed are heavily soiled.

4.2.2 Washing with Automatic operation



- Washing with automatic stop. The machine starts when a basket is pushed into it. The basket stays in the washing zone until the next basket pushes it onwards. The machine stops automatically after a set period of time if no new basket is fed in.
- Push the basket carefully towards the feed opening until the feed device hooks the basket in place.
- To start the feed, press .

4.2.3 Washing with manual operation



- Washing without automatic stop. Manual operation is a good idea when the items are heavily soiled. If you only feed in one basket, it stops and stays in the washing zone. The time in the zone is decided by the operator. The basket is pushed out of the machine when a new basket is fed in.
- Push the basket carefully towards the feed opening until the feed device hooks the basket in place.
- To start the feed, press .

4.2.4 Cancelling washing

It is possible to interrupt the wash by pressing Start/Stop (a) on the touch panel.

4.2.5 Emergency stop function

The machine has an emergency stop button (3).

If an emergency stop button is pressed during operation, the reason for the emergency stop must be rectified. The emergency stop is then reset by turning the emergency stop button in the direction indicated by the arrows on the emergency stop button. You must reset the alarm on the touch panel before you can restart the machine.

4.2.6 Guaranteed final rinse

The temperature of the final rinse water is always correct and the right amount of rinse water is always used.



If there is an error during the final rinse, this is indicated by an alarm and information on what must be done.



4.2.7 Changing the water



To achieve the best possible washing results, it is important that the water is changed frequently. However, always change the water in the event of foam problems in the tank.

- Open the machine doors.
- Remove the filters and filter tray, and clean them.
- Empty the tank by turning the level pipe a quarter of a turn.
- Refit the level pipe, filters and filter tray.
- Close the machine doors.
- Refilling of the machine is started by pressing "START" located on the touch panel .



A guide to changing the water is also displayed on the panel when the function for this has been selected. This is done by pressing the menu button  and then selecting water change .

Recommendations

- Change the water if a large amount of foam forms.
- If a large number of items need washing before lunch and relatively few during the afternoon, change the water directly after the lunchtime wash.
- If a large number of items need to be washed after breakfast and after lunch, change the water twice, both after breakfast and after lunch.

4.2.8 Checking the wash result



The dishware should be checked after each wash for:

PROBLEM	CAUSES & MEASURES
Starch spots	<ul style="list-style-type: none"> • Scraping: Important to remove as much food particles as possible before washing. This also means that the water in the machine does not need to be changed as often. Scrape better. • Detergent and drying agent dosage: If using liquid detergent and drying agent, the same make and type of detergent and drying agent should be used. A service technician should be contacted to rinse the equipment with water when replacing the detergent and drying agent. The dosing affects both detergent and drying results of the dishware. The hardness level of the water affects the consumption of detergent. Contact the detergent supplier. • Temperatures: At incorrect temperatures the dishes will not be clean. Contact a service technician if you need to change the set values. • Program selection: Program with too short a washing time selected. Choose a program with a longer washing time. • Cleaning the machine: Insufficient cleaning of the machine affects the results of the washing. Ensure better cleaning of the machine. • Placing dishes in baskets: Incorrectly placed items can mean that the washing water does not reach the items during washing and rinsing. • Soaking: Items with hard dried food. Soak the dishes in water. Do NOT use washing-up liquid.
Misting	
Protein residues	
Detergent residues	

4.3 After use – Cleaning

HACCP

HACCP is a preventive inspection system to ensure hygiene requirements are met during the washing process and cleaning of the machine. As a result of its design, the machine meets strict hygiene requirements. Regular, thorough cleaning is also important from a hygiene perspective. A machine that is properly cleaned helps produce a good wash result, reduces the risk of dirt accumulating, increases the service life of the machine and reduces the risk of emergency shut-down.

See the WEB Tool manual for the HACCP alarm options.



- All internal cleaning can and should take place from the front side of the machine to avoid the risk of crushing injuries beside the feed cradle.

4.3.1 Incorrect cleaning methods



N.B.! An incorrect cleaning method may damage the machine. The following points must be observed:

- Do NOT use steel wool as it will cause corrosion to form on the machine.
- If detergent is used, it must not contain abrasives. Detergents containing abrasives will damage the stainless steel panels.
- The exterior of the machine must not be hosed. Water can enter the machine and damage the control panel and electrical equipment.
- Pressure washers and steam can damage the machine and must NOT be used for cleaning purposes. Never use a pressure washer to clean the floor within 1 metre of the machine. The supplier cannot be held liable for any faults caused by the use of pressure washers on the machine and any such use may invalidate the warranty. There is a risk of splashing even if the floor is hosed down.

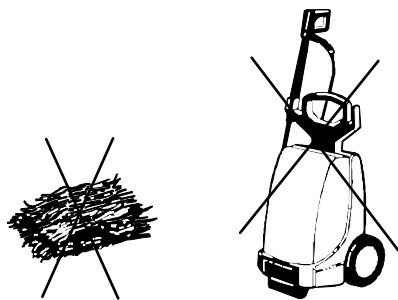

WD9_07

Steel wool and pressure washers must not be used for cleaning

4.3.2 Emptying and daily cleaning



A guide to emptying and cleaning is also displayed on the panel when the relevant function has been selected.

Machines with manual emptying and manual cleaning

- Open the machine doors.
- Unhook all of the curtains.
- Remove the filters and filter tray.
- Empty the tank by turning the level pipe a quarter of a turn.
- Remove the level pipe and the outlet seal.
- Carefully clean all of the parts removed from the machine. N.B.! Never leave the curtains, level pipes and outlet seals so that the rubber sleeve rests on a surface. The sleeve can become deformed leading to the risk of water leakage in the tanks.
- Clean the wash arms, including the nozzles.
- Clean the wash nozzles.
- Clean the doors. Wipe the rubber strips on the doors which are fitted at the top of the back of the doors.
- Rinse all the inside surfaces of the machine and clean the tanks. Use our Cleaning Gun (WD240.9009) for best results.
- Turn off the machine using ON/OFF.
- Leave the machine with the doors open.

Machines with manual emptying and automatic cleaning



The outer curtains should remain in the machine while the machine is being emptied and cleaned.

- Open the machine doors.
- Unhook the curtains. N.B.! Leave the outermost curtains on both the infeed and outfeed side.
- Remove the filters and filter tray.
- Empty the tank by turning the level pipe a quarter of a turn.
- Remove the level pipe and drain seals.
- Close the machine doors.
- Press  to start the internal cleaning.
- Remove the remaining curtains.
- Carefully clean all of the parts removed from the machine. N.B.! Never leave the curtains, level pipes and outlet seals so that the rubber sleeve rests on a surface. The sleeve can become deformed leading to the risk of water leakage in the tanks.
- Clean the wash arms, including the nozzles.
- Clean the wash nozzles.
- Clean the doors. Wipe the rubber strips on the doors which are fitted at the top of the back of the doors.
- Turn off the machine using ON/OFF.
- Leave the machine with the doors open.

Externally

Wipe the outside of the machine with a soft, damp cloth.

4.3.3 Cleaning and checking each week or as required

Once the daily cleaning is complete, you have the option of proceeding to the weekly cleaning and can also follow the instructions on the touch panel for this.

Weekly cleaning should be more thorough than daily cleaning. In addition to the daily cleaning measures, clean the machine as per these instructions:

- Clean the washer arms. Brush and rinse the washer arms using the Cleaning brush (WD721.0301) and clean the nozzles.
- Check and clean the rinse nozzles.
- Remove and clean the doors. Open the door, depress the catch and lift the door vertically.
- Refit all cleaned components.
- Decalcify the machine when necessary.



Cleaning brush WD721.0301

The door springs may be cleaned as required by rinsing these from the side. Use our Cleaning Gun (WD240.9009) for best results. The springs must NOT be removed! The door in front of the spring being cleaned must be closed.



4.3.4 Operating problems



Check:

- Has the appliance been used according to the instructions?
- Are all the removable parts in their correct place?
- Are there any error messages on the display?
- Are the fuses in the electrical cabinet still intact? Ask service personnel to check the fuses.

Troubleshooting

If the touch panel screen gives no indication of whether the ON/OFF button has been pressed, check the main switch to see whether it is turned on. If the problem persists, contact authorised service personnel.

The figure on the touch panel will change when an error or an alarm is presented. There are three different levels.

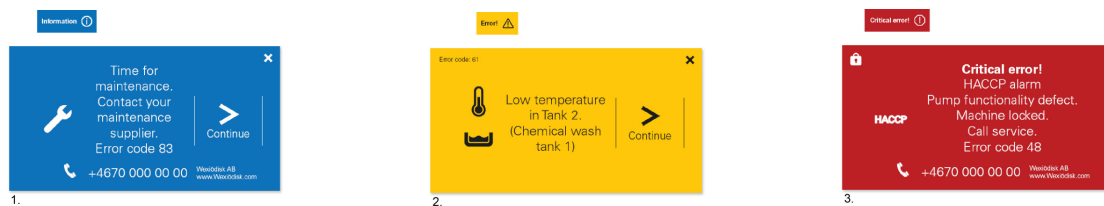

1. Information alarms (blue), which can be dealt with by the operator
2. Error alarms (yellow), which can often be dealt with by the operator
3. Critical error alarms (red), where service personnel must be contacted

The majority of these alarms can be remedied by the operator. Some blue alarms that have been dealt with by the operator a number of times will eventually change to yellow or red alarms, meaning that service personnel must be contacted.

Depending on previous settings, the machine may be stopped but not restarted until the cause of the alarm has been addressed. The operator is assisted by guides presented on the touch panel to perform measures or alternatively contact details for a service provider will be displayed.

In addition to the errors shown on the touch panel, other problems can occur. The table below shows some problems which can be rectified by the operator.

PROBLEM	CAUSE	ACTION
The machine does not fill with water.	The incoming water stopcock is closed.	Open the tap.
	The door/hood is open.	Close the door/hood.
	The final rinse pipe nozzles are blocked.	Clean the wash nozzles.
The machine fills slowly.	The final rinse pipe nozzles are blocked.	Clean the wash nozzles.
The machine does not stop filling.	Level pipe or drain seal not in place.	Fit the level pipe or drain seal.
	The level pipe or one of drain seals' rubber sleeves are not sealing against the bottom plate.	Check that the level pipe and drain seals are closed. Replace the rubber sleeves, if they are damaged.
The machine does not start washing.	The door/hood is open.	Close the door/hood.
	Dishware is blocking the magnet in the door.	Remove the dishware in question.
	Outward feed conveyor limit switch has been activated.	Remove the basket from the limit switch.
Noise from the washing pump.	Low water level. Foam in the tank.	Check the level. Change the water.
The machine is not cleaning properly.	The rinse and wash nozzles are clogged with dirt.	Check and clean the nozzles.
	There is too little detergent.	Check the amount of detergent. The hose must be submerged in liquid and the filter in the hose must be clean.
	The water in the tank is too dirty.	Change the water.
	Foam forming in the tank.	Check that the washing temperature is not too low and that the correct detergent is being used.
	The contact time is too short.	Select a longer contact time.
	Dirt has dried on the dishware to be washed.	Soak the dishware before washing.
	The dishware is incorrectly positioned in the baskets.	Use the correct type of washing basket and accessories to ensure that the dishware is correctly positioned.
	Detergent and drying agent of another make than usual are used.	Use the same make and type as before.
The dishware has tipped over in the baskets.	The dishware is incorrectly positioned in the baskets.	Put the dishware in the correct position.
	Light dishware need washing.	Use a net grid to hold the items.
Dishware does not dry.	The rinse nozzles are blocked.	Check and clean the nozzles.
	Too little rinsing agent.	Check the amount of rinsing agent. The hose must be submerged in liquid and the filter in the hose must be clean.
	The washed items have been left in the machine.	Remove the washed items once the programme has ended.

All errors displayed on the touch panel have an error code, which is displayed in the alarm. This error code must be specified when contacting service personnel.



Call the service company and state the following:

- Machine type and model.
- Machine serial number and date when the machine was installed.
- The error code displayed on the touch panel.
- What happened/was being done immediately before the fault occurred?

Information alarms (blue)

An information alarm is generated, e.g. because a predetermined number of wash cycles has been reached.

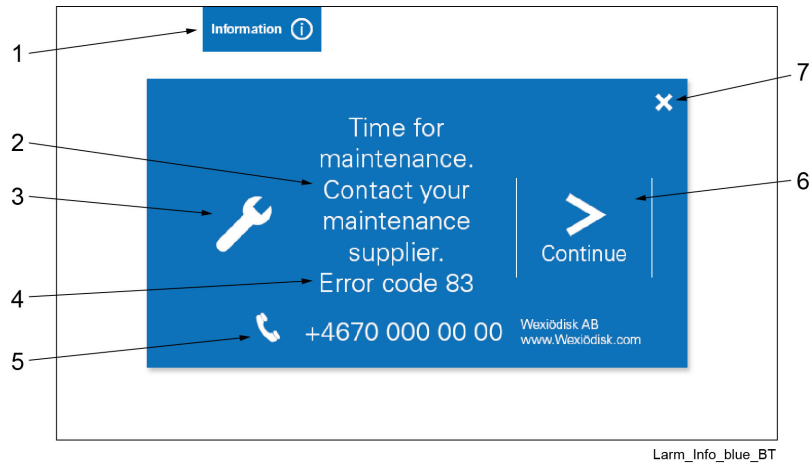

1. Type of alarm and minimise / maximise
2. Descriptive text
3. Symbol for type of alarm (maintenance)
4. Error code
5. Name and contact details of service personnel
6. Continue to next screen
7. Reset alarm



The information alarm can be minimised and then maximised by clicking on the button (1)

Follow the instructions on the touch panel, which are displayed by clicking on the symbol (6).

The information alarm can normally be reset using the X button (7), if you do not wish to click through the entire guide.

Error alarms (yellow)

An error alarm is generated, e.g. because of a low temperature in one of the tanks.

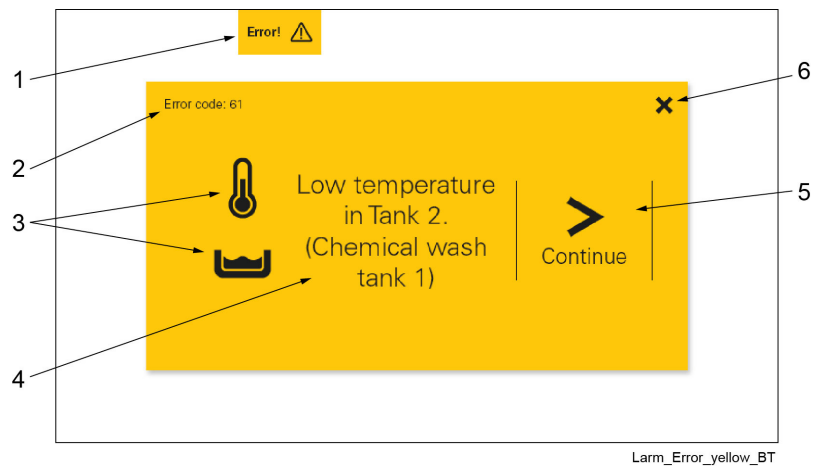

1. Type of alarm and minimise / maximise
2. Error code
3. Symbol for type of alarm
4. Descriptive text
5. Continue to next screen
6. Reset alarm



The alarm can be minimised and then maximised by clicking on the button (1)

Follow the instructions on the touch panel, which are displayed by clicking on the symbol (5).

The alarm can be reset using the X button (6) if you do not wish to click through the entire guide.

Critical error alarms (red)

A critical error alarm is generated because a serious error has occurred. The majority of these alarms cannot be reset by the operator, and service personnel must be contacted.

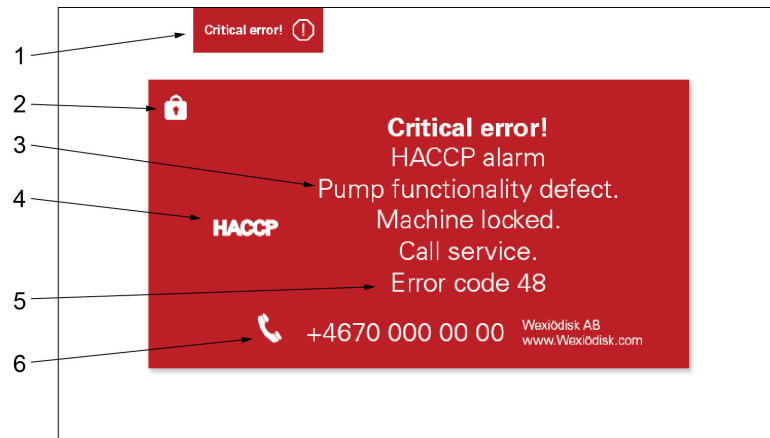

Larm_Critical error_red_BT

1. Type of alarm and minimise / maximise
2. Login symbol
3. Descriptive text
4. Symbol for type of alarm
5. Error code
6. Name and contact details of service personnel

5. Technical specifications

The manufacturer reserves the right to make changes to the technical data.

TECHNICAL DATA	
Pump motor, chemical wash (kW)	1.5
Pump motor, final rinse (kW)	0.11
Drive motor (kW)	0.12
Booster pump (kW) *	0.58
Booster heater (kW)	12 / 2x9 *
Tank heater, chemical wash (kW)	6
Tank volume, chemical wash tank (litres)	67
Tank volume, final rinse tank (litres)	6
Weight, machine in operation (kg)	350
Enclosure protection class (IP)	55

* option

CAPACITY AND OPERATING DATA	
Normal wash capacity (baskets/hour) *	50-100
Capacity in accordance with DIN 10510 (baskets/hour)	56
Hot water consumption, normal final rinse (litres/basket)	2
Surface temperature at a room temperature of 20 °C (°C)	35
Sound pressure level, LPA (dBA) **	69
Sound power level, LWA (dBA) **	83

* option

** in accordance with EN 60 335-2-58, §ZAA.2.8 with instruments that satisfy class 1.

Measurements of the sound pressure level on site are performed in three places 20 cm from the edges of the front at a height of 1.55 m using a microphone. When measuring sound power level, create an imaginary measurement area consisting of five sides at a distance of 1 m from all edges of the machine.

CONNECTION, ELECTRICALLY HEATED MACHINE	
Total connected load (kW)	19.7
Main fuse 400-415 V 3N~ (A) *	35 / 50 **/ 63**
Max. connection area 400V 3N~ (L1-L3, N, PE) Cu (mm ²)	25
Main fuse 400-440 V 3~ (A) *	35 / 50 **
Max. connection area 400-440 V 3~ (L1-L3, PE) Cu (mm ²)	25
Main fuse 230 V 3~ (A) *	63 / 100 **
Max. connection area 230 V 3~ (L1-L3, PE) Cu (mm ²)	25

* Other voltages on request

** Option

WATER, DRAIN AND VENTILATION CONNECTIONS	
Water quality, hardness (°dH)	2–7
Water connection 5-70 °C (internal thread)	R½"
Waste pipe connection, PP pipe (ø mm)	50
Hot water capacity, pressure (kPa) **	250–600
Water capacity, hot water, flow (litres/minute)	11
Floor drain, capacity (litres/sec.)	3
Ventilation requirement (m ³ /h)	1200
Ventilation connection, infeed ø125mm (m ³ /h)	400
Ventilation connection, outfeed ø160mm (m ³ /h)	1200
Heat load to room, latent / sensible / total (kW)	3.0 / 4.5 / 7.5

* option

** At lower pressures, the machine should be supplemented with a break tank

SIZE AND WEIGHT FOR TRANSPORT *	
Size, LxWxH (m) **	2.1 x 0.8 x 2.0
Weight (kg) **	280

* Normal delivery fully assembled. If necessary, delivered in smaller components.

** Including packaging