

Translation of the original instructions

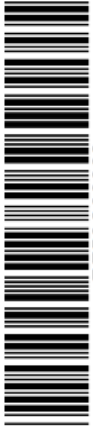

RF50C00082

METOS HiChef

UTILISATION AND MAINTENANCE MANUAL

REV 03-05/2023



Congratulations for having acquired our equipment!

Work has become much more simple thanks to the intuitive graphics of the user interface, designed to make easier the access to the functions, with a representation that is immediately identifiable and that favours the interaction between the user and the device.

A concentrate of technology in one single machine that will allow you to perform different and complementary activities for optimum efficiency in the kitchen: in this way you will be immediately operational, without starting any complex procedure.

This manual has the objective of providing all the necessary information for the correct use of the equipment and the execution of an efficient maintenance.

Before starting any operation it is necessary to carefully read the instructions contained herein, because they offer indispensable indications concerning the safety status of the equipment.

SAFETY WARNINGS.....	5
SAFETY WARNINGS FOR USE	5
CORRECT USE OF THE EQUIPMENT	5
IN CASE OF EQUIPMENT MALFUNCTIONING.....	6
RISKS ASSOCIATED WITH THE USE OF THE EQUIPMENT.....	6
LEARNING ABOUT THE EQUIPMENT.....	7
HOW THE EQUIPMENT WORKS.....	7
CORRECTLY LOADING THE EQUIPMENT	9
ACHIEVE BETTER RESULTS AND WORK SAFELY.....	12
HOW TO USE THE NEEDLE PROBE	12
USE.....	13
TURNING ON AND OFF.....	13
KEYBOARD LOCK AND UNLOCK.....	13
INITIAL SETTINGS MACHINE NAME - LANGUAGE - UNIT OF MEASUREMENT - STAND-BY.....	14
INITIAL SETTINGS DATE / TIME / TIME ZONE	14
INITIAL SETTINGS WIRELESS MANAGER.....	15
MANUAL FUNCTIONS	
BLAST CHILLING DEEP FREEZING.....	16
CONTINUOUS CYCLE.....	18
DEFROST.....	20
PRESERVATION MAINTAINING	22
PROOFING AND RETARDER PROOFING.....	23
SLOW COOKING.....	27
SLOW LOW HUMIDITY COOKING	28
PASTEURISATION.....	29
CRYSTALLISATION.....	31
MELTING CHOCOLATE.....	33
DEHYDRATION.....	35
YOGHURT	37
ANISAKIS KILLER TENIA KILLER.....	39
SPECIAL FUNCTIONS	
PRE-COOLING	40
PREHEATING.....	41
HYGIENE.....	42
DEFROST.....	43
NEEDLE PROBE HEATING	44
DRYING.....	45
MULTIFUNCTION	
LAUNCH A RECIPE IN THE MEMORY.....	46
CREATE A NEW RECIPE.....	47
DELETE RENAME A RECIPE SAVE IT AS A FAVOURITE.....	49
MAINTENANCE.....	50
CLEANING OF EXTERNAL STEEL SURFACES.....	50
CLEANING THE EQUIPMENT CHAMBER.....	50
TOUCH SCREEN.....	50
CLEANING THE GRILLES.....	51
PERIODS OF INACTIVITY.....	51
AFTER-SALES ASSISTANCE.....	52
ALARMS	53
DISPOSAL AND END OF SERVICE LIFES.....	55
WARRANTY.....	55

SAFETY WARNINGS BEFORE USE

- Any utilisation and cleaning performed not in compliance with that specified and foreseen in this booklet is considered as incorrect and may cause damages, injuries or fatal incidents, will void the warranty and exempt the manufacturer from any responsibility.
- This appliance can be used by children aged from 8 years and above and persons with reduced physical, sensory or mental capabilities or lack of experience and knowledge if they have been given supervision and instruction concerning use of the appliance in a safe way and understand the hazard involved. Children must not play with the appliance. Cleaning and user maintenance shall not be made by children without supervision.



Attention! Risk of fire and flammable materials. If the equipment uses R290 coolant, every possible precaution must be taken to avoid any danger related to the flammability of this gas.



Attention! Electrocutation hazard. Do not approach electrical parts with wet hands or barefoot.

- It is absolutely forbidden to tamper with or remove the safety devices provided (protective grilles, safety warning labels, etc...). The manufacturer declines any responsibility should the instructions above not be complied with.
- Do not insert screwdrivers or other tools between the guards (fan guards, evaporators, etc.).
- To ensure optimum functionality of the compressor and evaporator unit, never obstruct the suitable air intakes.
- In case of fire, do not use water, keep CO₂ extinguishers available (carbon dioxide) and cool the motor installation compartment as quickly as possible.
- During use, the use of PPE (personal protective equipment) is essential; the identification and selection of adequate personal protective equipment is the responsibility of the employer or workplace manager. The identified devices must be worn by the operators. During ordinary use, gloves protect your hands from the cold pan. Below is a list of the main personal protective equipment (PPE) to be used during the various work operations.

OPERATION	PROTECTIVE CLOTHING	SAFETY FOOTWEAR	GLOVES	GOGGLES	CRASH HELMET OR SAFETY HELMET
Ordinary use	■	■	□		
Ordinary cleaning		■	■	□	

■ Mandatory personal protective equipment (PPE).
 □ Personal protective equipment (PPE) to be used if necessary

CORRECT USE OF THE EQUIPMENT

- This equipment is considered an agrifood machine (CE Regulation no. 1935/2004), intended for the processing of food products in industrial and professional kitchens. It is not suitable for the preservation of pharmaceutical or chemical products, or any other non-food product.
- Specifically:
 - Blast Chillers (+90/+3°C) (+90/-18°C): are adequate for the quick lowering of foodstuff temperature, in order to keep unchanged its organoleptic properties;
 - Retarder-proofers (-15/+40°C) (-2/+40°C): they are suitable for the preservation of doughs with temporary preservation.
- The appliance is not an oven and is not suitable for carrying out only and exclusively cooking cycles.
- With the purpose of achieving the best equipment performance, it is necessary to observe the following indications:
 - Do not introduce uncovered liquids, live animals, various objects or corrosive products into the equipment.
 - Pack or protect food with other means, particularly if containing aromas or spices.
 - Position the foodstuff inside the equipment without disturbing the air circulation, do not place paper,

SAFETY WARNINGS

- cardboard, cutting boards, etc. over the grilles, which may obstruct the air flow.
- Avoid as much as possible frequent and prolonged door opening.
- If the door has been opened, wait some time before opening it again.
- The maximum load (evenly distributed) per tray or rack is 20 kg (GN 1/1) or 35kg (GN 2/1).
- The refrigeration equipment is built and designed with adequate features to guarantee the safety and health of the users, avoiding the presence of dangerous edges, sharp surfaces or elements that extend beyond the main volume. Its stability is ensured even with open doors, however it is forbidden to hang on the doors.
- Failure to comply with these rules may cause damage and injuries, also fatal, and will void the warranty.

IN CASE OF EQUIPMENT MALFUNCTIONING...

- If the equipment does not work properly or if functional or structural problems are noticed, disconnect it from the electrical and water source and contact an assistance centre authorised by the manufacturer, and do not attempt to repair it yourself. The use of original spare parts is recommended. The manufacturer declines from any responsibility for the use of non-original spare parts.
- To be sure that the equipment is maintained in perfect use and safety conditions, we recommend the execution of a maintenance and inspection service by an authorised assistance centre, at least once a year.

RISKS ASSOCIATED WITH USE OF THE EQUIPMENT

- RISKS DUE TO DISPLACEMENT ON WHEELS: if the equipment is supported by wheels, be careful during displacements to avoid pressing the equipment strongly, because it may tip or get damaged, pay attention also to eventual unevenness of the rolling surface. The equipment supported on wheels cannot be levelled, therefore be sure that the supporting surface is perfectly horizontal and flat. Always lock the wheels with the devices provided.
- RISKS DUE TO MOBILE ELEMENTS: the only mobile element present is the fan, but it presents no risk because it is protected by a protective grille fastened with bolts.
-  RISKS DUE TO LOW/HIGH TEMPERATURES: warning labels indicating "DANGER DUE TO TEMPERATURE" are affixed close to the dangerous zones with low/high temperatures.
- RISKS DUE TO ELECTRICAL POWER: the risks of an electrical nature are solved by the design of the electrical installation according to the CEI EN 60335-1 standard. Appropriate warning labels indicating "high voltage" identify the zones with dangers of an electrical nature.
- Noise level less than 70 dB.

RESIDUAL RISKS

- The correct design of the equipment and the installation of adequate protections do not completely eliminate the risks to the operator. This manual contains the list of personal protective equipment (PPE) that the operator must use. Sufficient spaces are provided during the installation phases of the equipment to limit the risks; to maintain these conditions, the areas surrounding the equipment must be kept clean, dry, well lit and free from obstructions. Below is a list of the residual risks that remain on the machine.

RESIDUAL RISK	DESCRIPTION
Slip or fall	The operator can slip due to the presence of water, oil or dirt on the floor.
Burn or abrasion	The user intentionally or unintentionally touches some components inside the appliance (for example cold trays, fins and pipes of the cooling circuit) without using protective gloves.
Electrocution	Contact with live electrical parts during maintenance operations carried out without disconnecting the power supply.
Fall	The operator intervenes on the equipment using unsuitable systems to access the upper part.
Injuries	Specialized personnel may not fix the upper control panel correctly. The latter might detach and fall.
Tipping	During equipment packaging and handling operations using unsuitable lifting and/or handling systems or with an unbalanced load.
Coolant gas	Inhalation of coolant gas. The type of coolant is shown on the appliance data plate.

HOW THE EQUIPMENT WORKS

The equipment can work in:

- **manual**, i.e. manually setting the necessary parameters for each function (MANUAL menu)
- **automatic** (MULTIFUNCTION menu, see page xx); in this latter case it will be sufficient to choose the **category** (e.g. meat), the **type** (e.g. lamb) and the **type of recipe** to be started (e.g. roasting) without the need to enter other parameters.

In the MANUAL section there are several functions which are listed below:

SOFT / HARD blast chilling: it is used to quickly bring the temperature at the core of the product to + 3°C and reduces the natural evaporation of the product while maintaining its humidity, avoiding bacterial proliferation after cooking.

SOFT / HARD deep freezing: it is used to quickly bring the temperature at the core of the product to - 18°C and reduces the natural evaporation of the product while maintaining its humidity, avoiding bacterial proliferation after cooking.

Continuous cycle: the continuous cycle is used to operate the equipment continuously and to set the temperature and speed of the fans.

Defrost: Being able to control and determine defrosting of a product means keeping intact the organoleptic characteristics and optimising stock, avoiding unnecessary waste. Defrosting takes place in maximum food safety, through the slow reabsorption of the microcrystallised water inside the food. It is the ideal cycle for products to be served raw or cold, such as fish or patisserie products, because it does not damage their molecular structure.

Preservation: it is used to maintain the cold temperature set for an indefinite period of time. Storage in this appliance must be temporary, not prolonged over time, as occurs in a normal preserver.

Maintaining: it is used to maintain the set hot temperature for an indefinite period of time.

Proofing / Retarder Proofing

Flexibility in "just in time" production is the best way to optimise resources, manage time and to respond to the variability of demands.

Slow cooking: The control of temperature and its maintaining within the predefined values allow preparations which safeguard not only taste and flavour but also succulence and tenderness to give really exciting results. This function is very simple to use and is perfect for keeping food warm while serving, helping to improve preparation and organisation. This cycle can also be used in patisserie work for melting chocolate or candying fruit.

Slow low humidity cooking: Some types of foods require particularly delicate cooking processes, with low humidity.

Pasteurisation: it is used to sterilise sauces, creams or liquids with heat.

Crystallisation: The tempering or crystallisation of chocolate is a widely used technique in the processing of chocolate: it causes cocoa butter to crystallise correctly, thus obtaining a soft final product with a shiny appearance, without the typical white patina that can sometimes be seen on the surface of chocolate.

Melting chocolate: Chocolate is easily altered by heat because its main ingredients, cocoa and sugar, are mixed with cocoa butter which melts at a temperature of 38-40°C; if this threshold is exceeded, the structure is irreversibly altered.

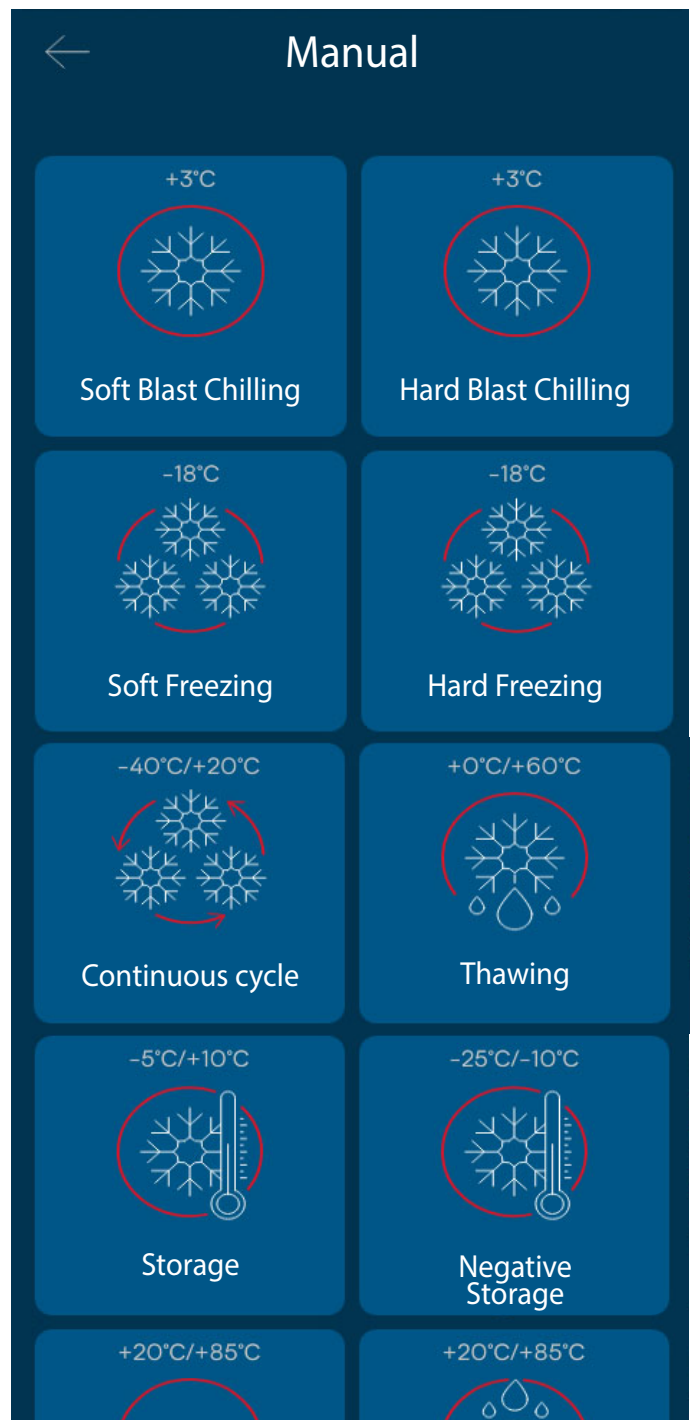

Dehydration: it is used to delicately dehydrate fruit, vegetables, meats and aromatic herbs.

Yoghurt: this cycle maintains an ideal temperature for the fermentation of yoghurt.

Anisakis killer, Parasites killer: the functions serve to eliminate the risks associated with the contamination of products by pathogens such as anisakis and tapeworm, ensuring maximum effectiveness in terms of food hygiene.

Chamber pre-cooling/pre-heating: allows pre-cooling or pre-heating of the cell before a cold or hot cycle.

LEARNING ABOUT THE EQUIPMENT

What is the use of a temperature-based blast chiller?

The blast chiller is a piece of equipment that decreases very quickly the temperature of the introduced foodstuff, either fresh or already cooked.

Fresh or recently cooked food have in fact the best organoleptic and flavour quality; however, if not consumed immediately, it loses its initial qualitative characteristics with the passage of time, and a multiplication of micro-organisms potentially dangerous for humans will take place.

Positive Blast Chilling is performed when the food is not consumed immediately after preparation, by reducing the product temperature within 90 minutes until it reaches +3°C at its core. After this, the product must be conserved under refrigeration at a temperature of 0/+3°C, therefore conserving its quality for up to 5 days.

Deep freezing is carried out to keep unchanged all the organoleptic characteristics of the food. The blast chiller reduces the product temperature until it reaches -18 degrees in the core. Then the product must be conserved in a freezer at a constant temperature of -20 degrees and can be consumed even after 3/18 months, according to the product, provided the cooling chain standards are complied with.

Regular refrigerators and freezers, as opposed to a blast chiller, don't have the features to quickly decrease the initial product temperature, as a result the later will be damaged at the organoleptic and flavour levels.

Why defrost in a controlled manner?

With the **Defrost** function, this equipment takes the frozen products to a positive temperature in a controlled and quick manner, in compliance with the HACCP standards: this means always remaining below the temperatures at which the bacteria flora reproduces in an exponential progression. Additionally, the cooking of food defrosted in a controlled manner brings advantages when compared to the cooking of an already cooked food, starting from an initial frozen condition, and also reduces the risk of having parts of the food not completely cooked.

What is Retarder Proofing for?

Controlled proofing is used for bread and patisserie doughs through the management of temperature, humidity and time. This is used to improve the quality of the product and to eliminate the night work of bakers: doughs are in fact prepared during the day. Once ready they are introduced into the equipment and, through programming, proofing is blocked until the bread is ready to be baked.

Why use the Slow Cooking function?

Initial experiments in cooking at low temperatures date back to almost two centuries ago and were conducted by Benjamin Thompson (1753-1814), a brilliant British physicist of American origins. The scientist, with practical experiments, noticed that meats cooked at low temperatures for very long times lost less weight than those subjected to different cooking, remaining softer, pink and tasty. Benjamin Thompson had already guessed, two centuries ago, what we know for sure today: slow and gentle cooking (Slow cooking) enhances the goodness of the ingredients without removing their tasty juices, maintains higher vitamin content and at the same time dissolves the connective tissues that make meat fibrous.

LEARNING ABOUT THE EQUIPMENT







CORRECTLY LOADING THE EQUIPMENT

The dishes are placed on a single layer, in containers:

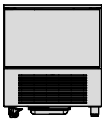
- uncovered;
- suitable for food use;
- resistant to the temperatures reached by the blast chilling and slow cooking cycles;
- with low edges (maximum 4.5 cm).

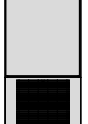
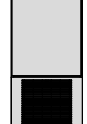
The recipients must be evenly and uniformly distributed inside the cell.

Correct positioning of the containers will allow the free circulation of air inside the cell: avoid obstructing the ventilation fans and overloading the appliance beyond the permitted limits.

																	
		061		061 R290		091		120		121		121 R290		161		161 R290	
Capacity chill in 120'	+65>+10°C EN17032	kg	30	30	45	-	65	-	65	65	80	80	100	-			
Capacity freez. in 270'	+65>-18°C EN17032	kg	20	20	30	-	45	-	45	40	55	50	60	-			
Type of pans/ grilles			GN1/1 600x400		GN1/1 600x400		GN1/1 600x400		GN1/1 600x400		GN1/1 600x400		GN 1/1 600x400				
Quantity of pans GN 1/1 - EN1	H 20 mm	n°	10	10	18	-	22	-	24	24	28	28	44	-			
	H 40 mm	n°	6	6	12	-	14	-	16	16	18	18	28	-			
	H 65 mm	n°	5	5	9	-	11	-	12	12	14	14	22	-			

TO LEARN ABOUT
THE EQUIPMENT

SUBMARINE

EN17032

+65°C > +10°C

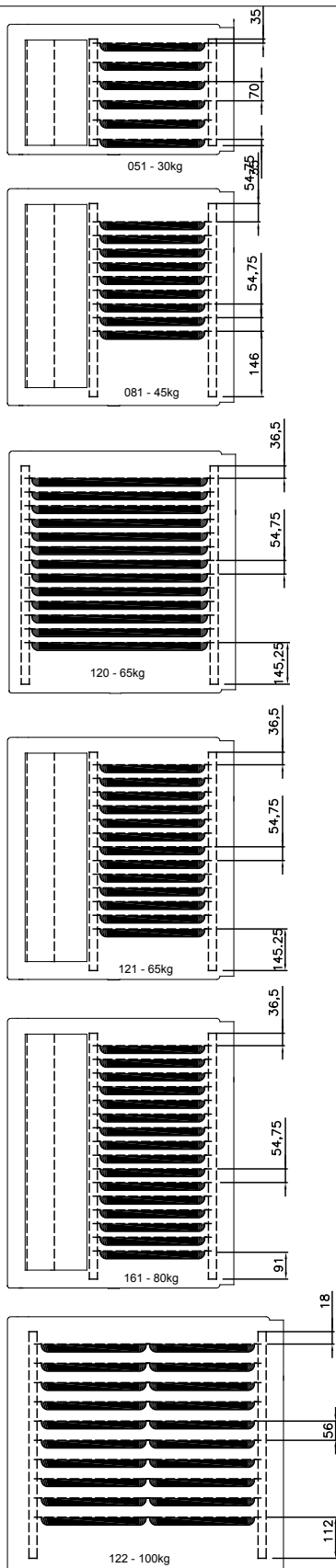

SUBMARINE

EN17032

+65°C > -18°C

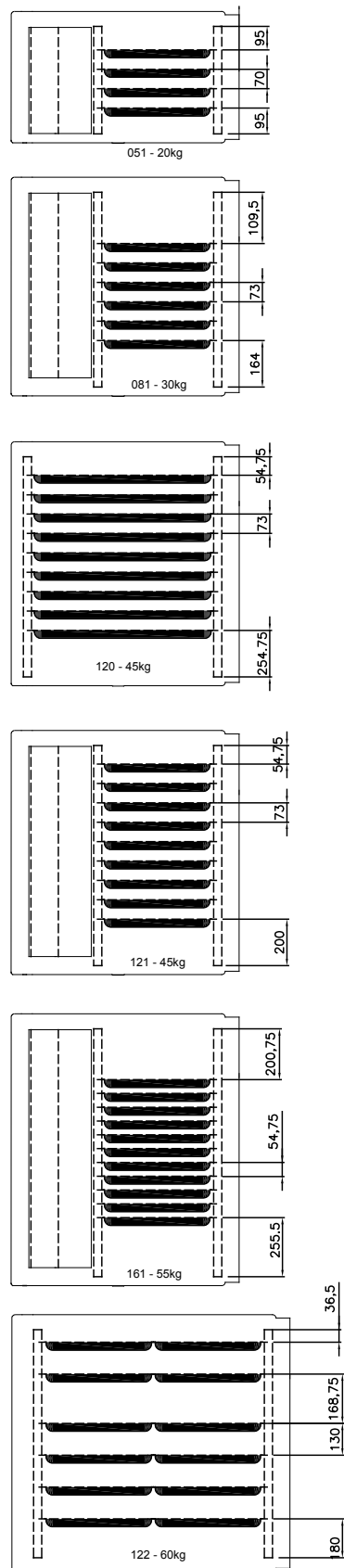

SUBMARINE R290

EN17032

+65°C > +10°C

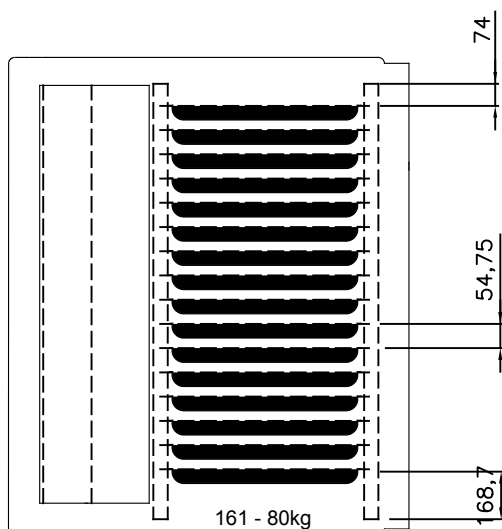
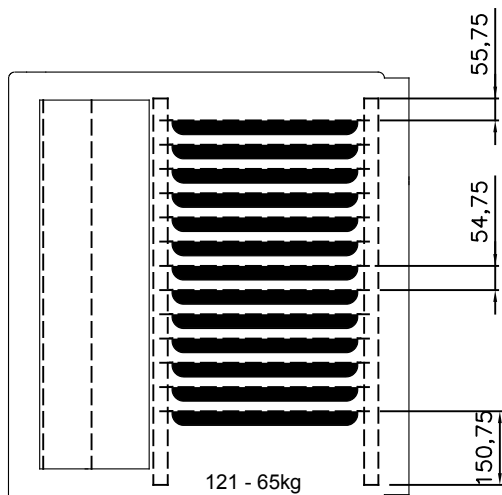
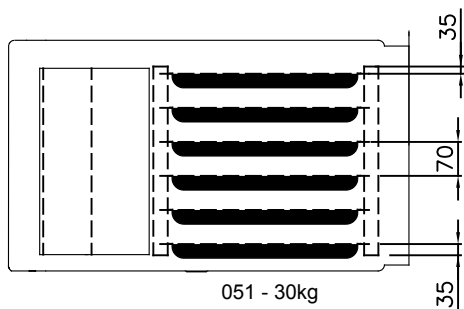

SUBMARINE R290

EN17032

+65°C > -18°C

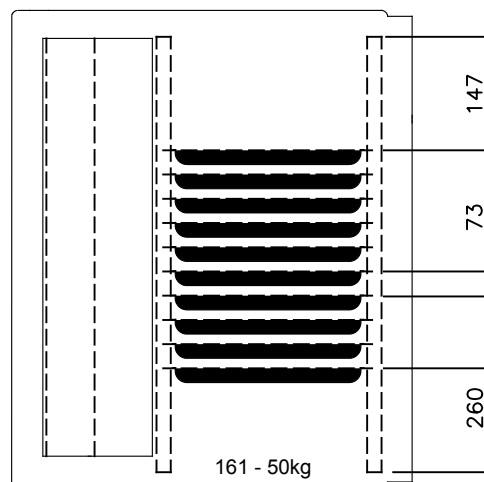
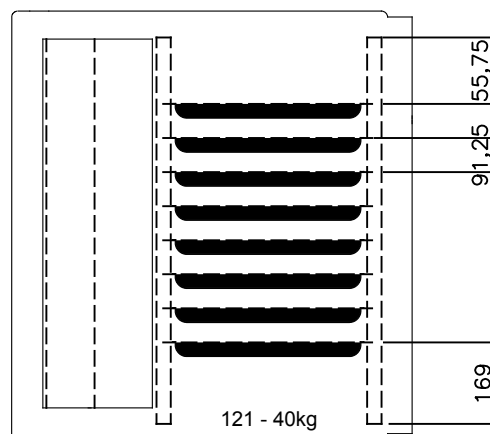
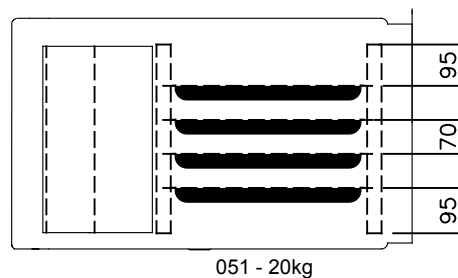

LEARNING ABOUT THE EQUIPMENT

ACHIEVE BETTER RESULTS AND WORK SAFELY

- Keep the air inlets of the motor compartment free of objects and clear of dust;
- wash periodically or replace the filter located behind the air inlets of the motor compartment;



For further information on how to remove the filter, see chap. Cleaning the grilles on p. 51.

- arrange the foods to be blast chilled or cooked as explained in the previous chapter;
- close the doors tightly during every work cycle;
- always keep the defrost water discharge hole unobstructed;
- avoid opening the doors during the positive or negative blast chilling/slow cooking cycles;
- carry out regularly the ordinary maintenance as specified in the dedicated section;



For more information about how to remove the filter consult par. MAINTENANCE on page 50.

- in the case of cooking with grilles of particularly fatty foods (for example poultry), insert a pan on the bottom of the chamber to collect the greases that could drip down from the food;
- do not use easily flammable foods or liquids (e.g. alcohol) during cooking.

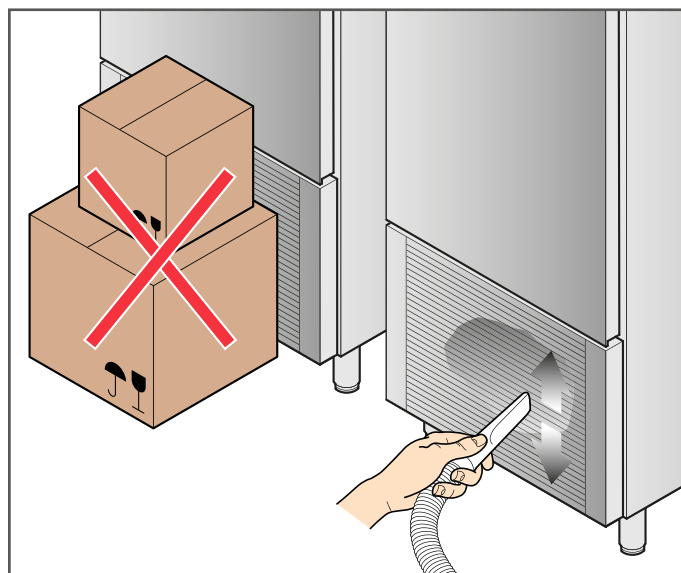

HOW TO USE THE NEEDLE PROBE

The needle probe, during a blast chilling or cooking cycle, detects the temperature at the "core" of the food: when it reaches the value set by the user or in the factory, it means that the food is blast chilled (Blast Chilling function) or cooked (**Slow Cooking** function).

The needle probe is inserted deeply into the food to be blast chilled/cooked: be sure that the needle tip reaches the "core" of the food, this means its most internal point, without extending out.

Be careful not to insert it in points with much grease or next to bones.

If the food thickness is too small, insert the probe parallel to supporting surface.

It is recommended to keep the probe always clean and hygienic.



HANDLE THE PROBE CAREFULLY AS IT IS POINTED AND, AFTER USE IN COOKING, REACHES HIGH TEMPERATURES.



The probe can be heated to facilitate its extraction from frozen foods, see page 44.

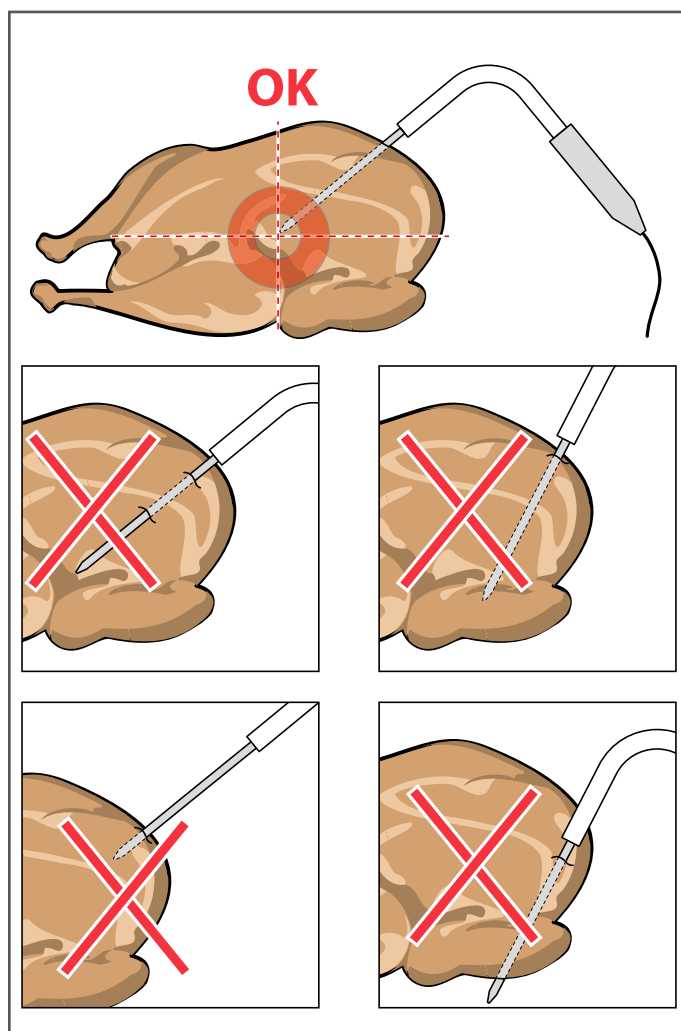

SWITCHING ON AND OFF | KEYBOARD LOCK AND UNLOCK

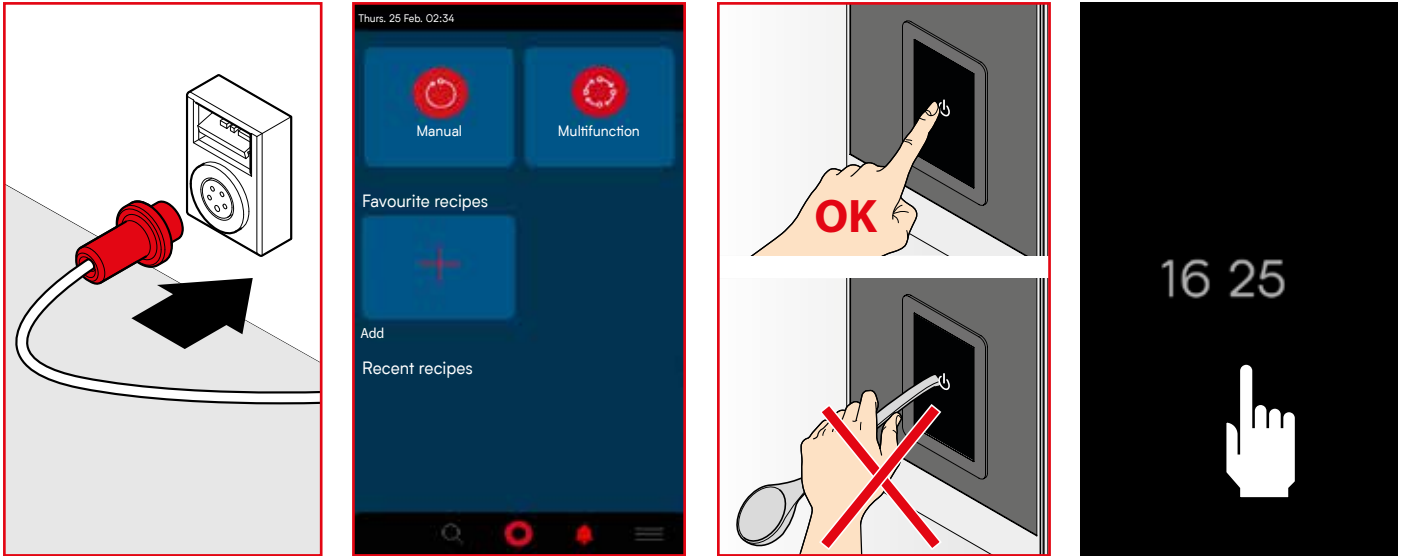

To switch on the equipment, insert the plug into the dedicated socket. After a few moments the main page will appear.

It is recommended to only use your fingers to touch the touch screen, avoiding the use of tools (e.g. forks, ladles, etc.).

After several minutes of disuse, the keyboard automatically locks to prevent the cycle in progress from being accidentally stopped. To unlock the keyboard, touch the display.

INITIAL SETTINGS | MACHINE NAME - LANGUAGE - UNIT OF MEASUREMENT - STAND-BY

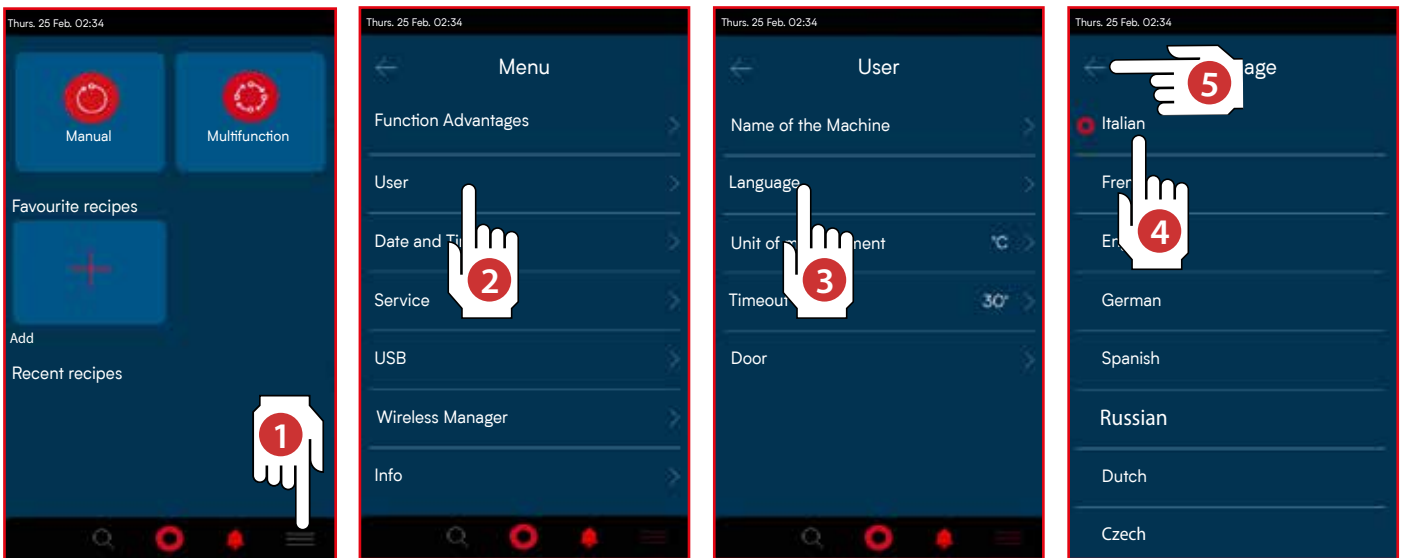

- 1 Tap the **Settings** key
- 2 Tap the **User** item.
- 3 On the screen that appears, it is possible to set the **machine name**, the **language** in which the entries are displayed, the **unit of measurement** (°C or °F), after how many **seconds of inactivity (timeout)** the machine goes into stand-by, or decide how to start a cycle (**door** menu - see next chapter).
- 4 Set the desired values or language.
- 5 Press the button -> several times to return to the main screen and save the entered values.

Please note: when setting the language, you are asked to confirm the restart of the system; the chosen language is displayed when the system is restarted.

INITIAL SETTINGS | DOOR

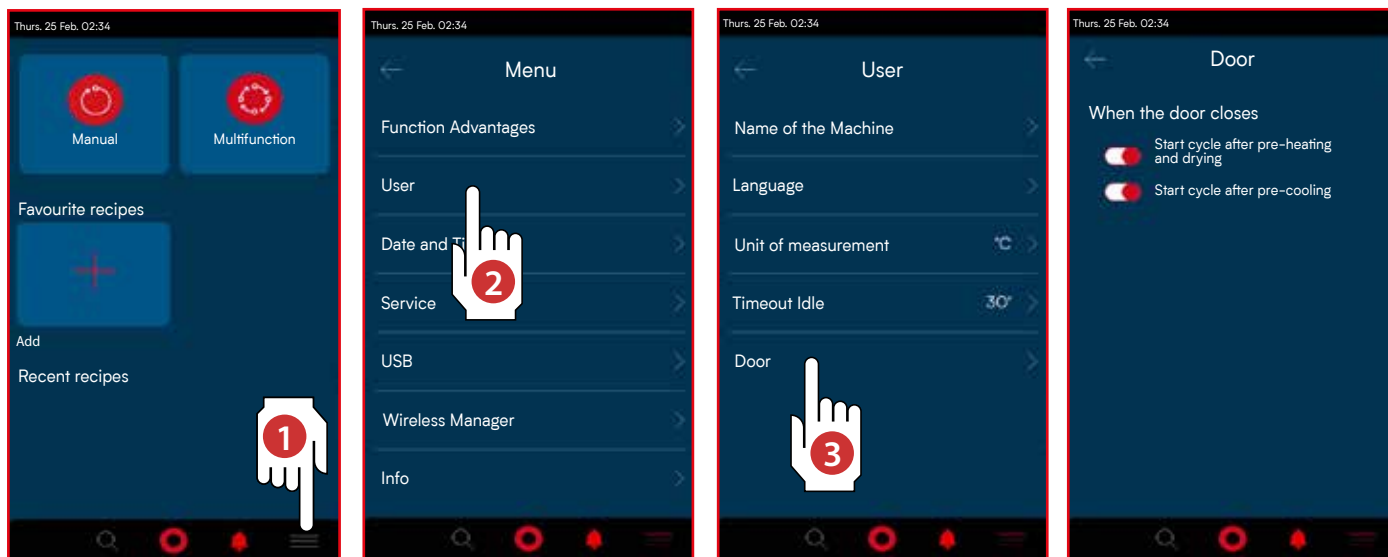

- 1 Touch the **Settings** key.
- 2 Touch **User**.
- 3 Touch **Door**: you can now select whether the cycle is started manually by pressing **Start Cycle** or **automatically** when the door is opened.

INITIAL SETTINGS | DATE / TIME / TIME ZONE

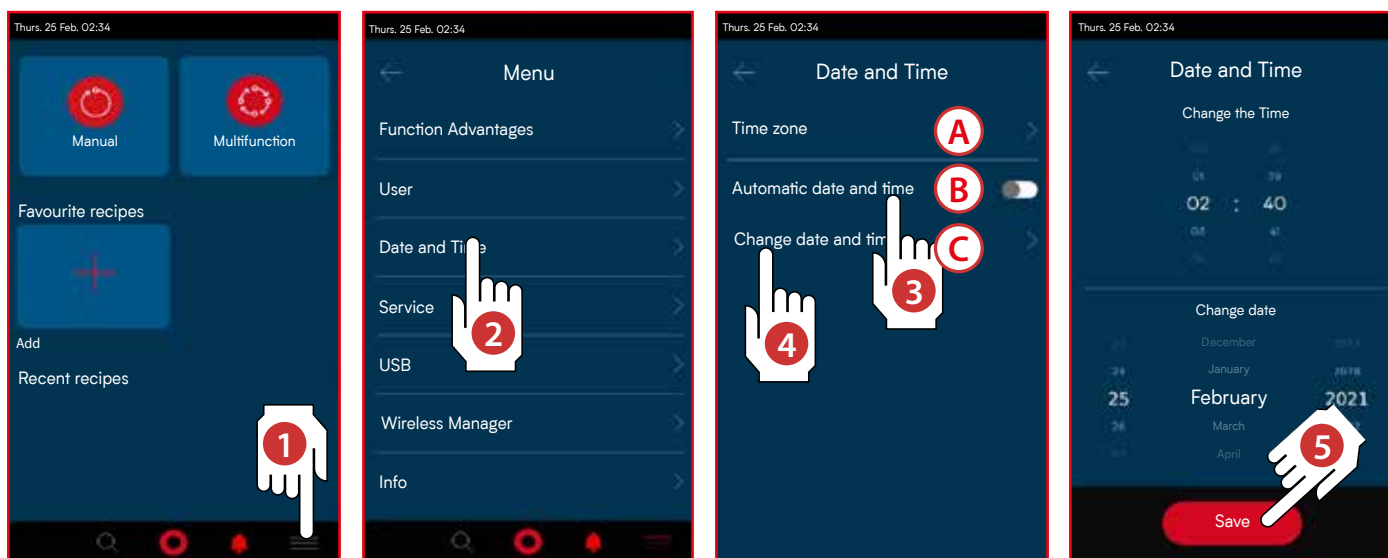

- 1 Tap the **Settings** key
- 2 Tap the **Date and time** item.
- 3 Set the desired values.
 - (A) Choose the **time zone** (e.g. for Italy +1.00 Berlin, Rome)
 - (B) Choose the **Date and Time** setup mode:
 - : automatic update (only selectable when Wi-Fi connection is present)
 - : manual update (using (C))
 - (C) Manual **Date and time** setup
- 4 Touch the item to set the **Date and Time** to manual (the item is only active and selectable if manual update was selected in step B).
- 5 Confirm the entered values with the **Save** button.

INITIAL SETTINGS | WIRELESS MANAGER

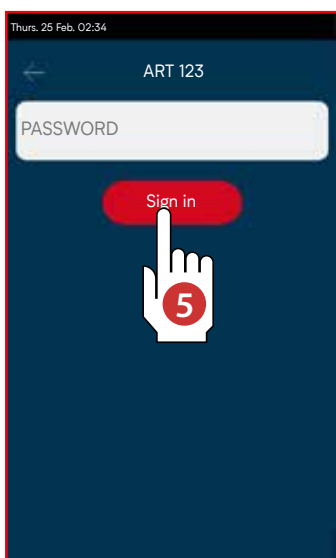
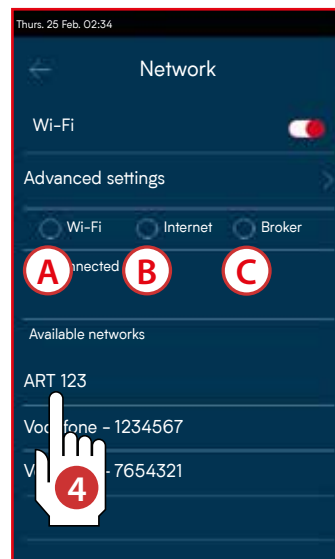
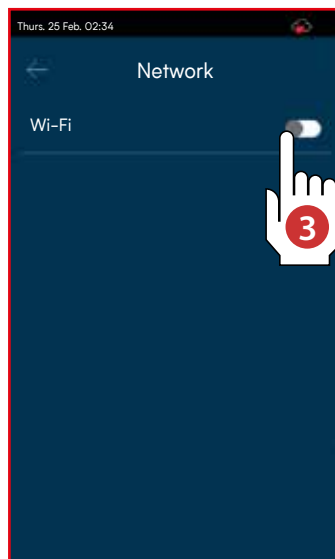
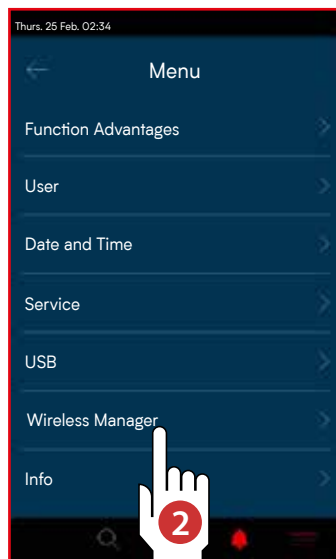

- 1 Touch the **Settings** key
- 2 Touch **Wireless Manager**.
- 3 Activate **Wi-Fi** network search
- 4 Select the desired network from those available
- 5 Enter the Access Password and confirm by pressing the **Login** button

Meaning of the LED:

- A Connection to the access point successful
- B Connected to the Internet
- C Connected to ColdCloud

BLAST CHILLING | DEEP FREEZING

A blast chiller is able to quickly lower the temperature of fresh or already cooked food to positive **+3°C (blast chilling)** or **negative -20°C (deep freezing)** values as required; in this way when they are regenerated for serving, they will maintain their organoleptic characteristics, their appearance and flavour as if they had just been prepared. It is advisable NOT to keep cooked food to be blast chilled and/or frozen for a long time at room temperature and to start the blast chilling or deep freezing cycle as soon as cooking is finished by introducing the food into the blast chiller at a temperature not lower than +70°C.

SOFT BLAST CHILLING/DEEP FREEZING: suitable for the most delicate dishes, such as desserts and vegetables.

HARD BLAST CHILLING/DEEP FREEZING: more aggressive cycle, ideal for large-sized foods or large quantities (e.g. meats).

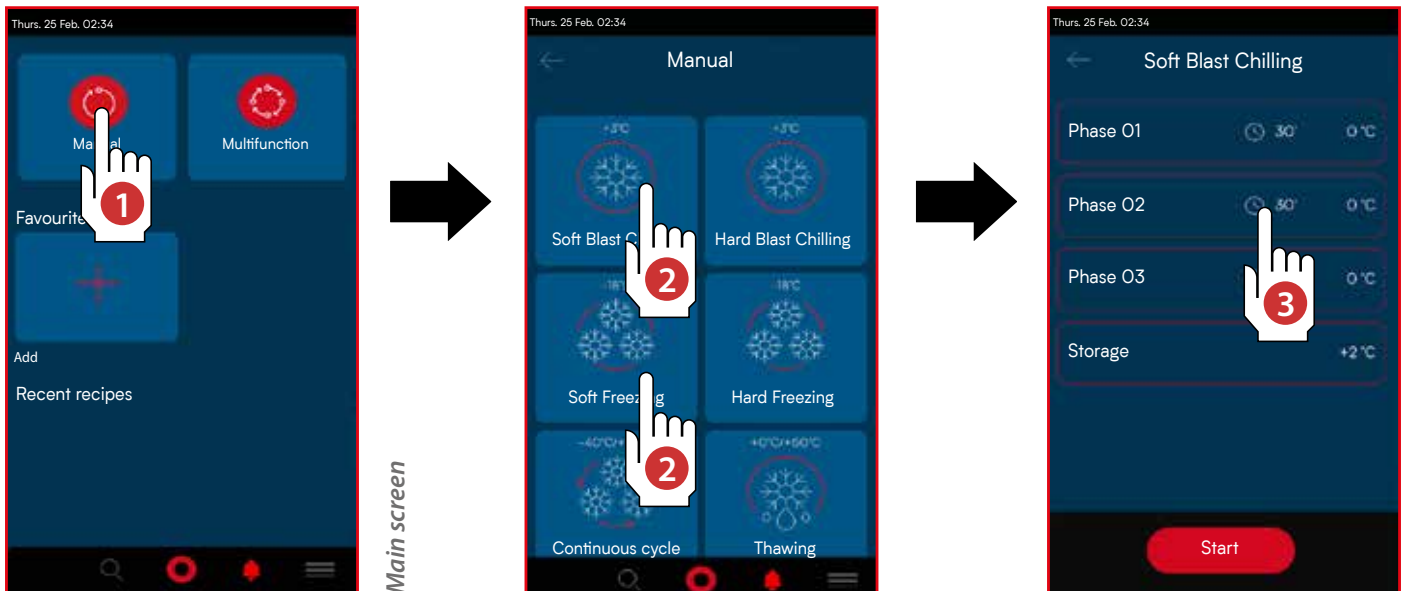

- 1 Tap the word **Manual**.
- 2 Select the wording **Blast Chilling (Soft or Hard)** or **Deep Freezing (Soft or Hard)**.
- 3 Each cycle consists of 3 phases + a preservation phase which is used to keep the blast chilled or deep frozen products at the temperature until they are removed, which must take place as soon as possible.

If changes to phases 01 - 02 - 03 or to the final preservation phase are necessary, tap the phase to be changed (in the example Phase 02).

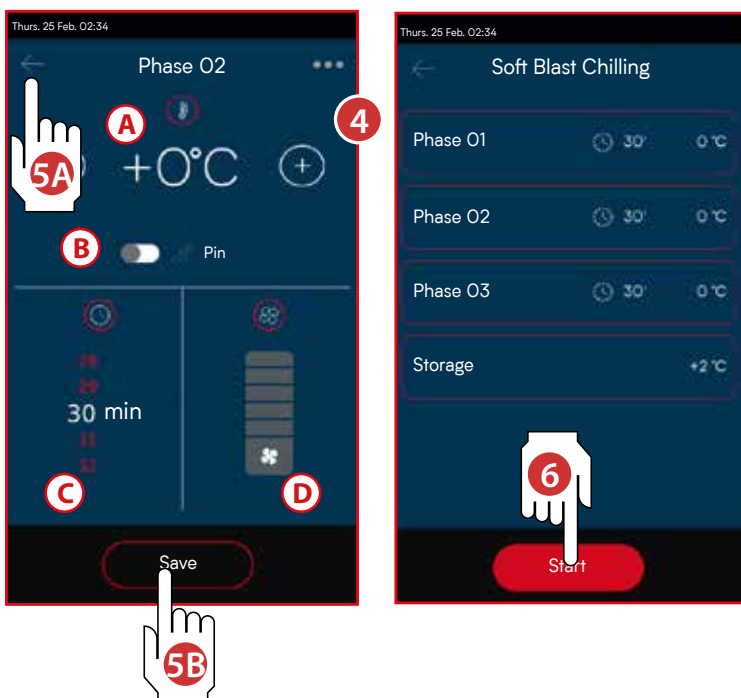

- 4 Set:
 - A the **temperature to be reached**.
 - B if working:
 - Needle** ► by setting a time: the cycle ends when the set time has elapsed.
 - Needle** ► using the needle probe: the cycle ends when a predetermined core temperature is reached (it is therefore necessary to insert the needle probe in the food to be blast chilled).
- Note: some phases can be set by time, others with a needle probe.
- C the **Duration** of the cycle (if a timed cycle has been chosen) or the **Needle probe temperature** (if a cycle with a probe has been chosen)
- D the **Fan speed**.
- 5 Go back using the **Arrow** key (to exit without saving) or touch the **Save** button (to save the entered values and exit).
- 6 Start the cycle by tapping the word **Start**.

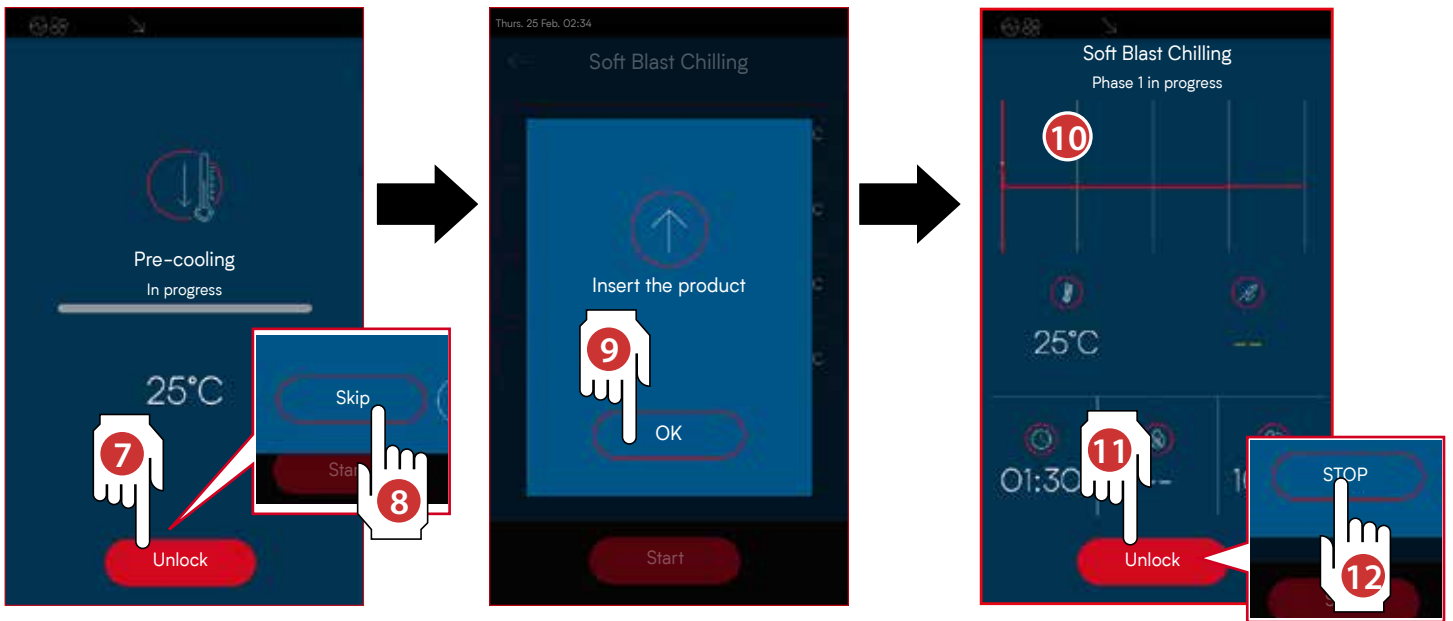

- 7 8** After touching **Start**, an automatic variable duration precooling of the chamber starts. If this is not required, press the **Release** button and then **Skip**.
- 9** When precooling has been completed, place the products to be blast chilled or frozen inside the cell and press **OK**. If the needle probe mode has been chosen, insert it in the food to be blast chilled (for further information on the core probe, see page 12)
- 10** The Blast Chilling or Deep Freezing cycle is in progress. If this mode has been selected:
 - Needle** ▶ *by setting a time: the cycle ends when the set time has elapsed.*
 - Needle** ▶ *using the needle probe: the cycle ends when a pre-set core temperature is reached.*
- 11 12** To stop the cycle early, press the **Unblock** button and then **Stop**.

At the end of the Blast Chilling or Deep Freezing cycle, **a preservation phase** of the products starts automatically (its parameters can be modified like a normal phase) to keep them at temperature until they are removed, which must take place in the shortest time possible.



In the case of fish products, especially if they are eaten raw or not cooked for a long time, it is necessary to perform negative blast chilling before consumption to avoid health risks linked to bacterial and parasitic contamination, in particular the *Anisakis simplex* larvae. If the larvae penetrate the gastric mucosa they cause violent abdominal pain, related to nausea and vomiting. In this case, one or two weeks after the infection, they work their way to the intestine and can cause a serious immunity response, accompanied by intermittent abdominal pain, nausea, diarrhoea and fever or intestinal perforation.

CONTINUOUS CYCLE

This function makes the oven work continuously according to a temperature and fan speed set by the user. The **continuous cycle** only ends when the **Skip button is pressed**.

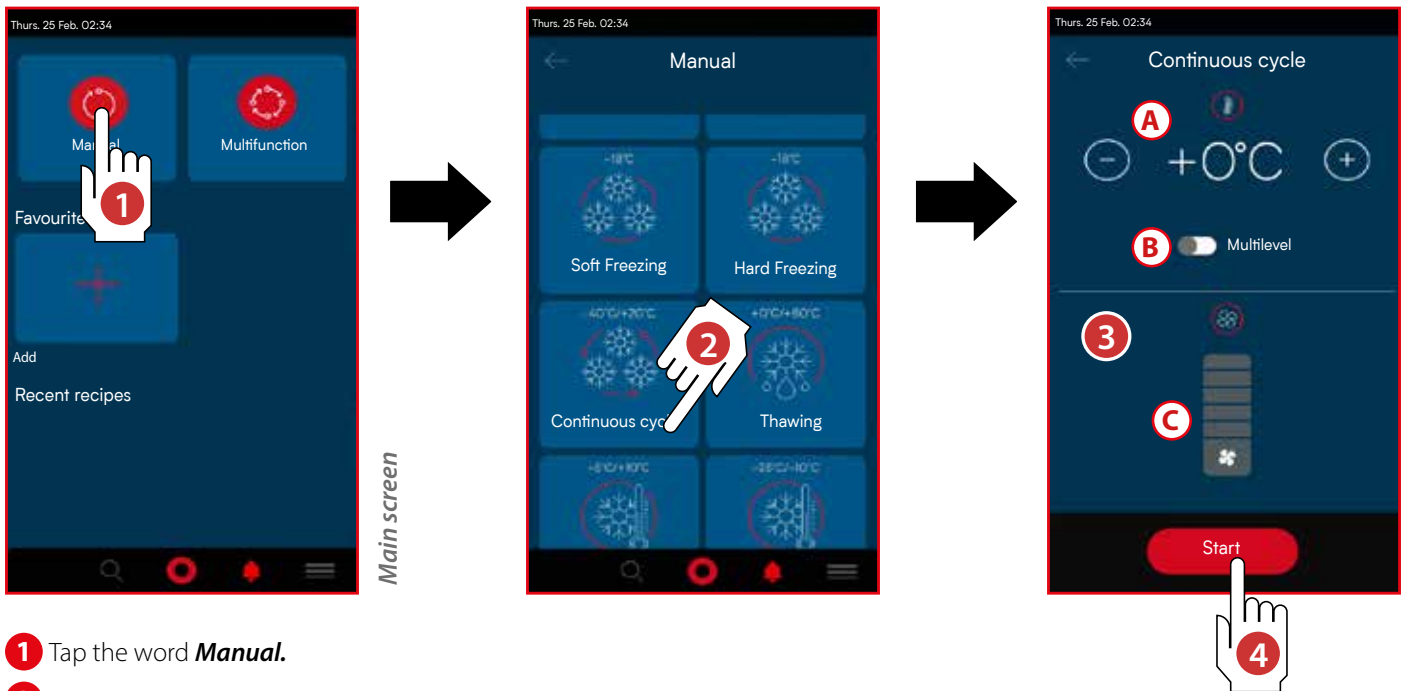

- 1 Tap the word **Manual**.
- 2 Select the wording **Continuous Cycle**.
- 3 Set:
 - A the **temperature to be reached**;
 - B to work in **Multilevel mode** (the **Multilevel function**, if activated, is used to set up to 9 timers, entering a duration for each. At the end of the set time, an acoustic signal will warn that the pan corresponding to the expired timer can be removed from the cell;
 - C the **Fan speed**.
- 4 Start the cycle by tapping the word **Start**.

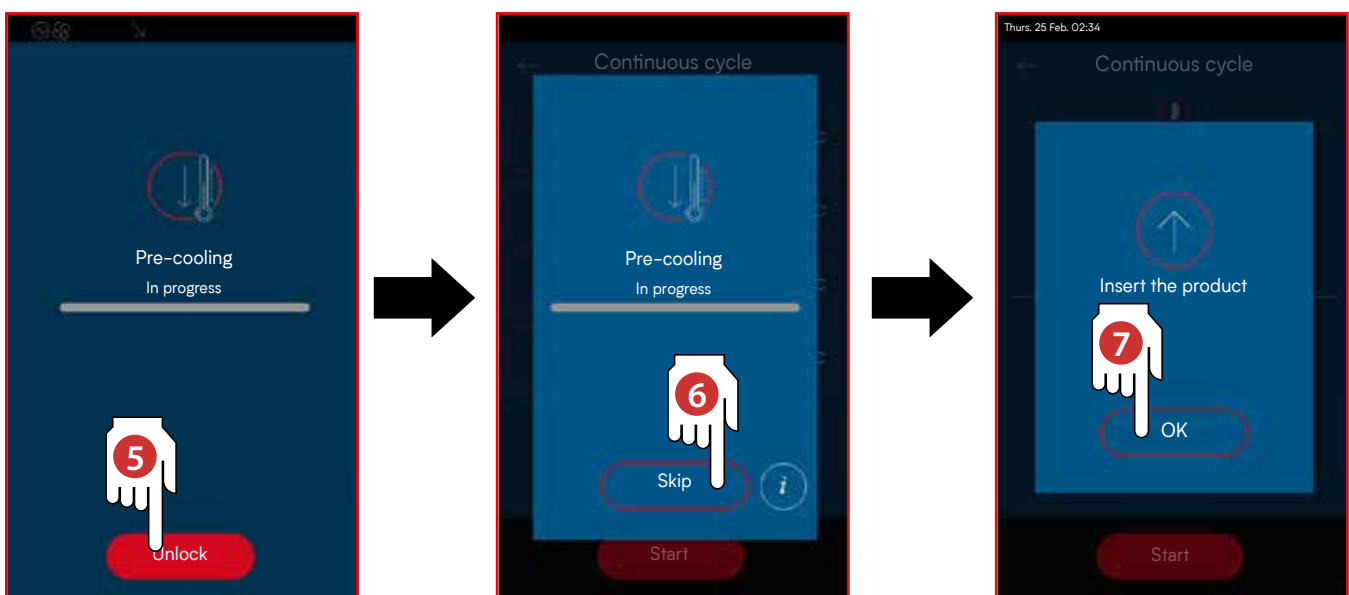

- 5 6 After touching **Start**, an automatic variable duration precooling of the chamber starts. If this is not required, press the **Release** button and then **Skip**.
- 7 When precooling has been completed, place the products to be blast chilled or frozen inside the cell and press **OK**. If the needle probe mode has been chosen, insert it in the food to be blast chilled (for further information on the core probe, see page 12)

CONTINUOUS NON MULTI-LEVEL CYCLE



- 8** The continuous cycle is in progress.
- 9 10** To stop it, press the **Unlock** button and then **Stop**.

MULTILEVEL CONTINUOUS CYCLE

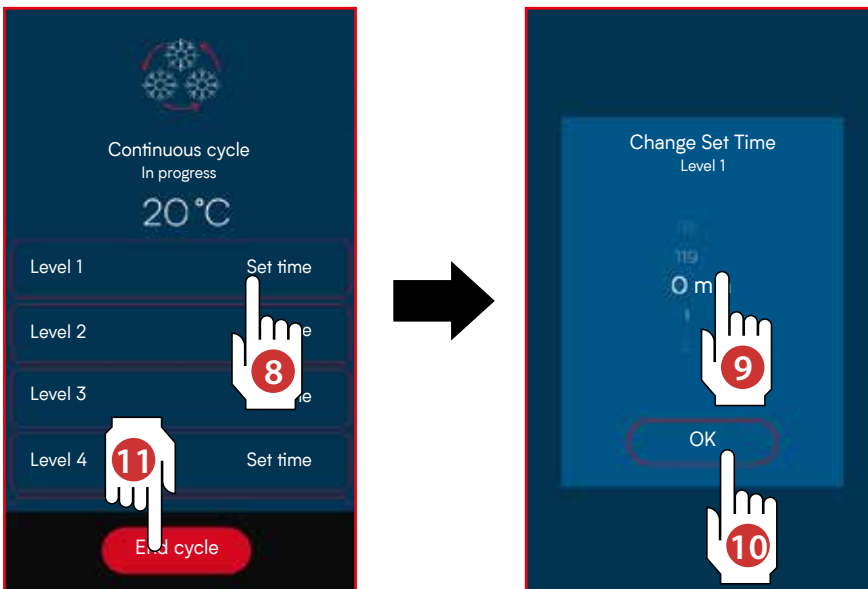

- 8 9 10** Set the desired time in minutes for each tray (level) (e.g. from 0 to 119 minutes). Confirm the entered time with "OK". The countdown of each timer set for each tray begins; when a timer expires, an acoustic signal sounds and a screen indicates which tray to remove.
- 11** To end the continuous cycle press the **End cycle button**.

DEFROST

The appliance defrosts frozen dishes in a controlled manner, slowly reabsorbing the microcrystallised water contained in the food; this allows the organoleptic and aesthetic characteristics of the food to be kept intact.



The supply of humidity is important if the foods are left to defrost free on pans (they could lose weight and become dehydrated) while it is not needed if they are closed in bags or containers.

The humidity to be added during the cycle can be set from 0 (no humidity supply) up to 100%.



1 Tap the word **Manual**.

2 Select the word **Defrost**.

3 Set:

A the **initial temperature** of the product to be frozen (e.g. -18°C) and the **final temperature** that the product must reach (e.g. 25°C)

B the **preservation temperature** (i.e. the temperature that the machine maintains inside the cell after the defrost cycle has finished. This temperature is maintained until the products are removed from the cell).

C the **Duration** of the defrost cycle.

D the **humidity in the cell**.

E the **Fan speed**.

4 Start the cycle by tapping the word **Start**.

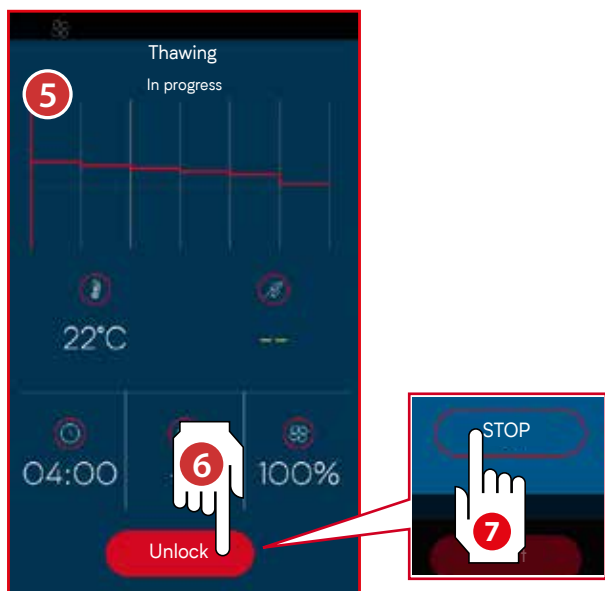

5 After tapping the word **Start**, defrosting begins and will end when the set time has elapsed.

6 7 To stop it, press the **Unlock** button and then **Stop**.

PRESERVATION | MAINTAINING

The equipment is able to maintain the set temperature for an indefinite period of time.

The equipment is not a preserver and the preservation function is intended as temporary.

In this way it will be possible to preserve food at negative or positive temperatures while waiting to be removed from the cell; this is particularly useful for keeping the dishes to be served at the optimum temperature.

PRESERVATION: the machine keeps indefinitely a temperature that can be set from -2°C to +18°C

MAINTAINING: the machine maintains indefinitely a temperature that can be set from +50°C to +70°C



- 1 Tap the word **Manual**.
- 2 Select the word **Preservation** or **Maintaining**
- 3 If changes are required, set:
 - A the **temperature** to be maintained
 - B the **Fan speed**.
- 4 Start the cycle by tapping the word **Start**.
- 5 6 The machine maintains the set temperature indefinitely; to interrupt the cycle, press the **Unblock** button and then **Stop**.

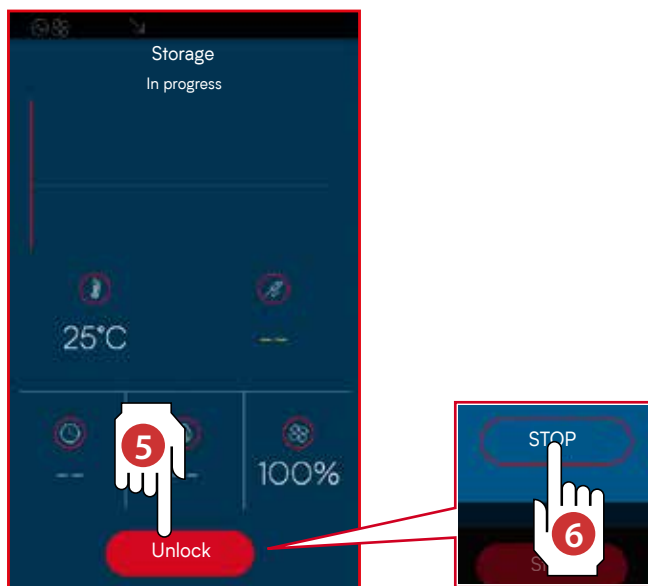

PROOFING AND RETARDER PROOFING

Controlled proofing is used for bread and patisserie doughs through the management of temperature, humidity and time. This is used to improve the quality of the product and to eliminate the night work of the bakers: doughs are in fact prepared during the day, once ready they are introduced into the Retarder Proofing equipment and, through programming, proofing is blocked until the time when the bread is ready to be baked.



HISTORY OF BREAD

The first appearance of bread: prehistory

Archaeologists have found grains of cereals in various prehistoric sites: it is therefore thought that bread was usually used as a food to supplement meat and that the first stable crops of cereals date back to the Neolithic era. Grains were crushed between two stones and then mixed with water to prepare a simple but very nutritious and always available food.

The peoples of the Mediterranean basin: the discovery of yeast

The Egyptians were one of the first peoples to cultivate cereals on a large scale: the lands around the Nile, thanks to silt, were in fact very fertile and therefore suitable for plantations of cereals, especially wheat.

Subsequently the crops extended to the whole Mediterranean basin, with a particularly favourable climate.

Initially, grains were pounded in a mortar, then, with a sieve, the nutritional part of the grain was separated from the outer husk. The flour thus obtained was mixed with water and cooked on stones or in containers placed inside holes dug into the ground and heated. In a later period the first cone-shaped clay ovens appeared: in the lower part the fire burned and in the upper part they baked bread.

To the initial mixture of water and flour, very simple, oil, milk, herbs, wine and honey were soon added and yeast appeared; in ancient times two types of yeast were mainly used, one was made with millet mixed with sweet wine and left to ferment, the other with wheat bran left to macerate for three days in sweet wine and then dried in the sun.

The great famines of the Middle Ages

In the IX and X century, it was not easy to find flour and consequently bread because the fields had been abandoned during the barbarian invasions and did not produce sufficient crops to feed the population.

The bread was therefore made with little flour and a lot of bran and less valuable cereals such as millet, acorn flour or lupidol and elm leaves were often used.

In the Middle Ages, the most common way to grind grain was to use expensive water mills run by expert millers and bakers.

The baker was required to produce and deliver well-baked and leavened bread or risk facing a monetary fine.

Up to the present day

Even today, especially in temperate areas, wheat is the most cultivated and most used cereal in the world for human consumption. The main producers are China and Canada. The countries of the European Union, among which France excels, have a total production equal to 15% of the world total.



WHY AND HOW MUCH TO HUMIDIFY

Humidification keeps the surface of doughs left to rise elastic and moist, avoiding the formation of a crust that could hinder proofing of the bread. Sweet doughs, given the presence of sugars and fats among the ingredients, are less affected by this problem, requiring lower percentages of humidity than salty ones.

PROOFING

The function consists of two phases, **proofing** and **baking delay**, each of which can be set differently.

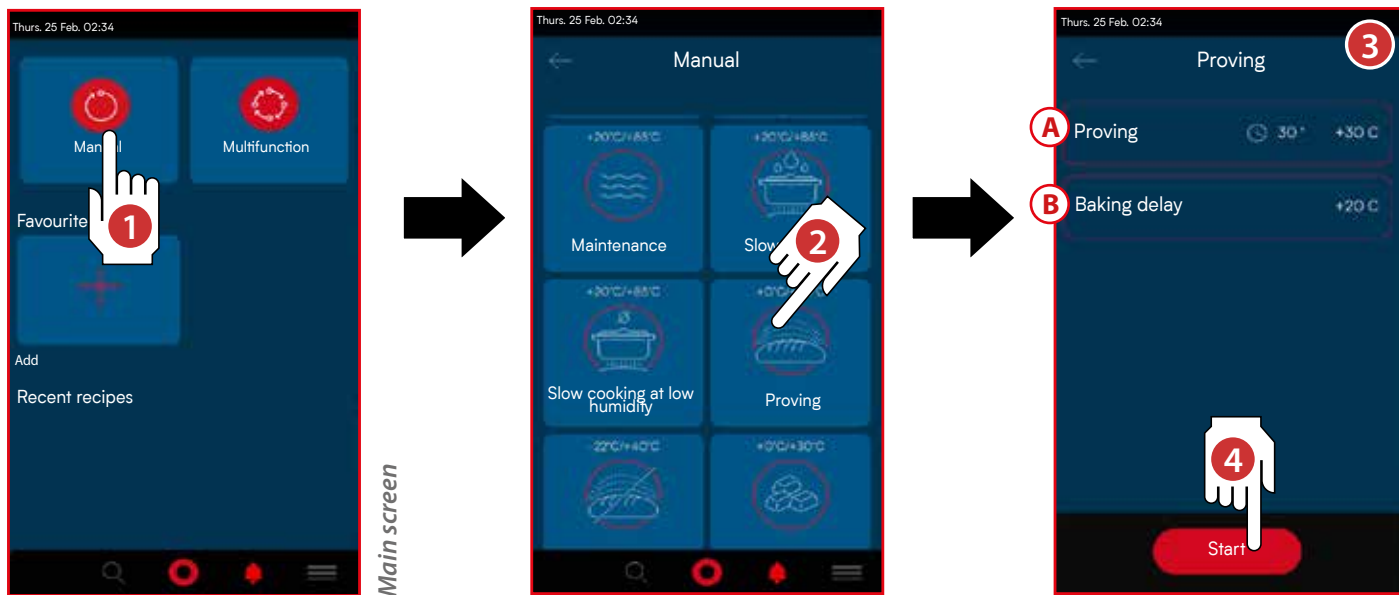

1 Tap the word **Manual**.

2 Select the word **Proving**.

3 Set:

A the parameters that the equipment must maintain during the product **proofing** phase by choosing:

- **chamber temperature**
- **proofing duration**
- **humidity**
- **fan speed**.

B the parameters that the equipment must maintain during the **product baking delay phase**, choosing:

- **chamber temperature**
- **proofing duration**
- **humidity**
- **fan speed**.

4 Start the cycle by tapping the word **Start**.

5 6 To stop the cycle, press the **Unlock** button and then **Stop**.

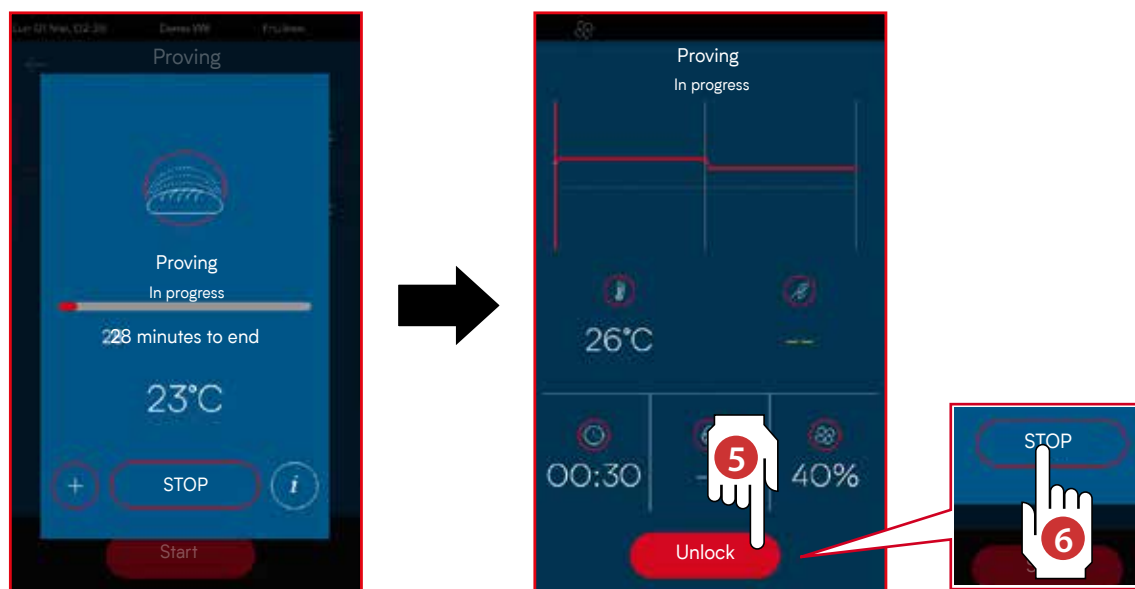

RETARDER PROOFING

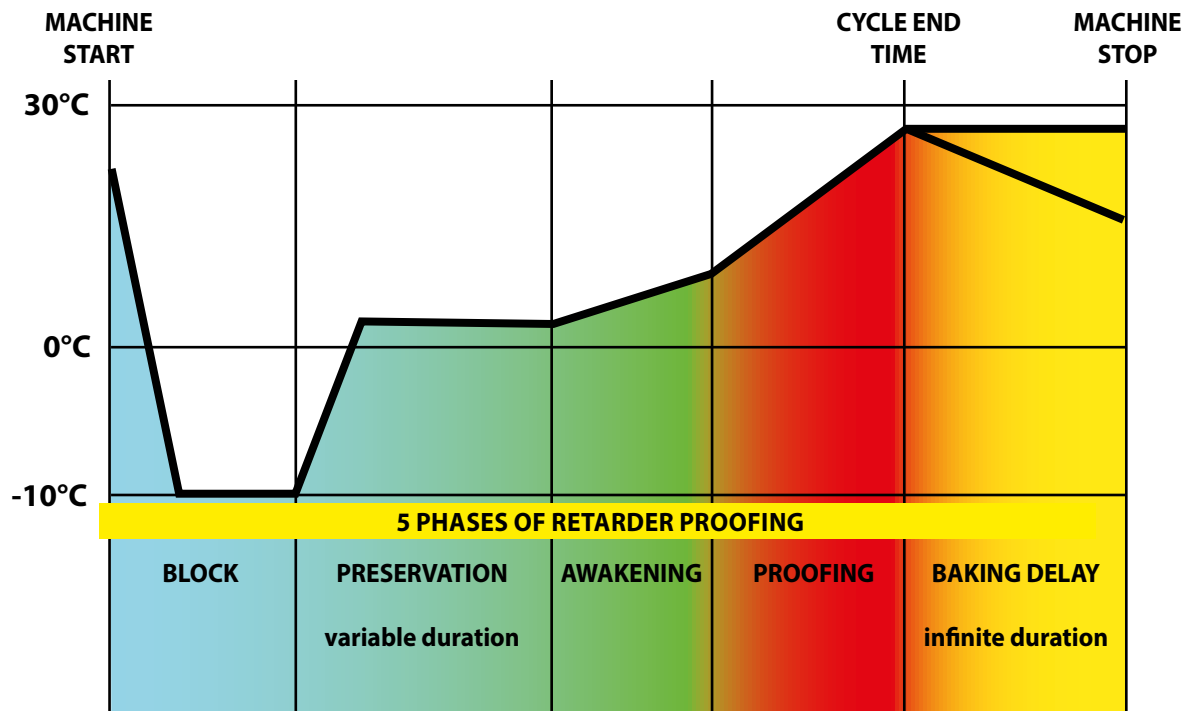
**Phase 1: BLOCK**

The **blocking** phase is the first phase of the *Retarder Proofing* cycle. It is used to "block" the yeasts contained in the prepared dough in order to delay proofing.

Phase 2: PRESERVATION

The **preservation** phase is the first phase of the *Retarder Proofing* cycle. It is used to preserve the dough at a temperature that is not frozen but at the same time does not awaken the yeasts, waiting for the awakening phase preceding the proofing to begin.

Phase 3: AWAKENING

The **awakening** phase is the third phase of the *Retarder Proofing* cycle. It is used to raise the temperature in the cell, awakening the yeasts of the dough, thus obtaining pre-proofing.

Phase 4: PROOFING

The **proofing** phase is the fourth phase of the *Retarder Proofing* cycle. It is used to complete the proofing of the dough in order to prepare it to be baked on the day and time set by the end user.

Phase 5: BAKING DELAY

The **baking delay** phase is the fifth phase of the *Retarder Proofing* cycle. It is used to keep the proofed dough waiting so it can be picked up and placed in the oven for baking. The baking delay phase is always involved but can be disabled by the user both in the cycle setting phase and also with the cycle in progress (in this case the machine will go into stand-by at the end of the proofing).

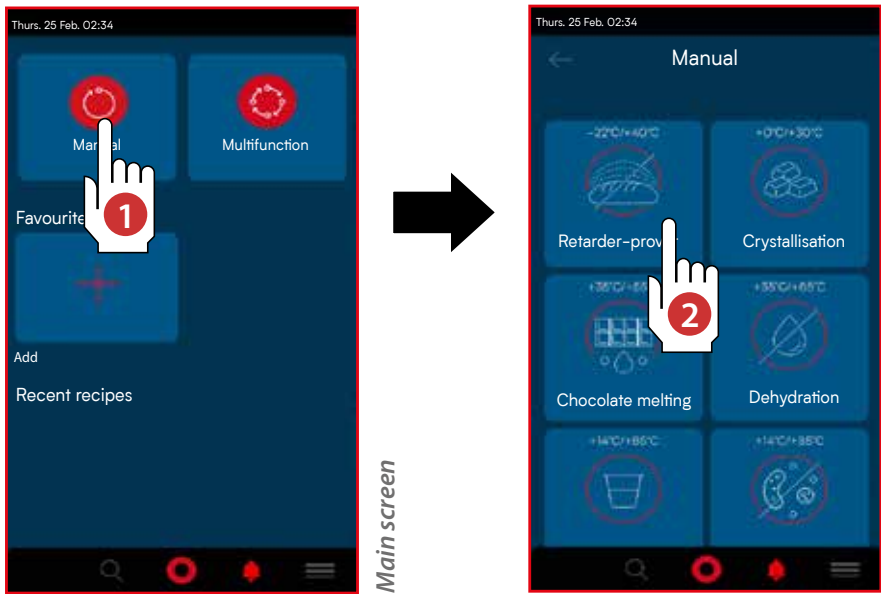

Main screen

- 1 Tap the word **Manual**.
- 2 Select the word **Retarder Proofing**.
- 3A 3B Set all **phases** (**stopping, preservation, awakening, proofing, baking delay**). For each of them it is possible to set:
 - A the **temperature** to be maintained during the phase (e.g. -4°C);
 - B the **duration** (e.g. 61 minutes);
 - C the **humidity** in the cell;
 - D the **fan** speed;
 - E the **end-of-cycle time** (i.e. the time at which the products to be baked should be ready) and the **cycle end date** (i.e. the date on which the products to be baked should be ready).
- 3C After completing the setup press **Save**.
- 4 Start the cycle by tapping the word **Start**.
- 5 6 To stop the cycle, press the **Unblock** button and then **Stop**.

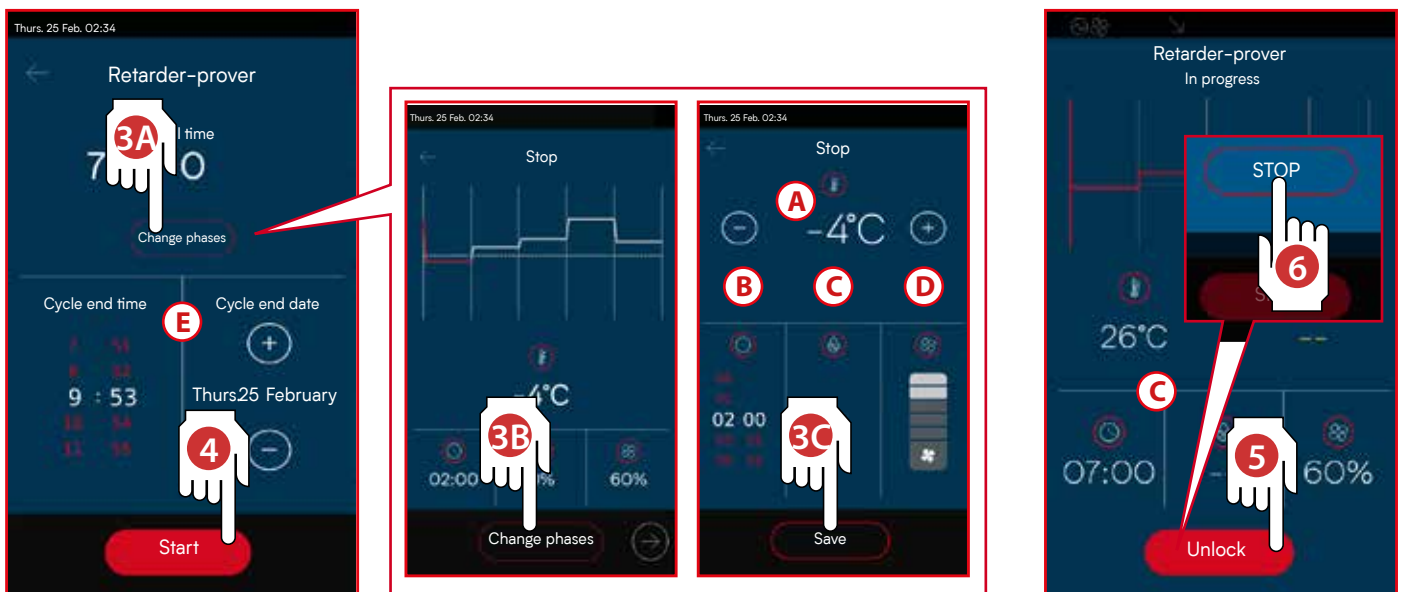

SLOW COOKING

Low temperature cooking allows cooking for very long times at low temperatures (up to a maximum of 85°C in the cooking chamber). A technique aimed at safeguarding the flavours, colours and textures of the dishes, which thanks to slow and non-aggressive cooking gives surprising results.

In this way:

- the organoleptic qualities of the raw materials, meat, fish, vegetables are enhanced
- the nutrients of the dishes are better preserved, keeping the contents of water-soluble vitamins higher;
- the meats remain tastier and lose less weight than those subjected to more "aggressive cooking"; in addition, the connective tissues that make meat fibrous are dissolved, making it softer;
- foods are more digestible.



- 1 Tap the word **Manual**.
- 2 Select the wording **Slow cooking**
- 3 If changes to phases O1 - O2 or to the final maintaining phase are necessary, tap the phase to be changed (in the example Phase O1).

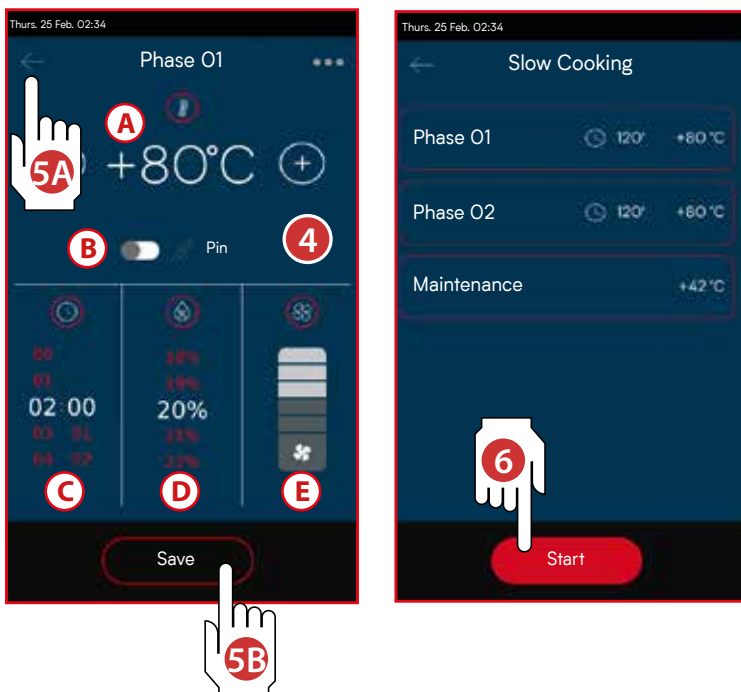

- 4 Set:
 - A the **temperature to be reached**.
 - B if working:
 - Needle ► by setting a time: the cycle ends when the set time has elapsed.
 - Needle ► using the needle probe: the cycle ends when a predetermined core temperature is reached (it is therefore necessary to insert the needle probe in the food to be blast chilled).

Note: some phases can be set by time, others with a needle probe.

 - C the **Duration** of the cycle (if a timed cycle has been chosen) or the **Needle probe temperature** (if a cycle with a probe has been chosen)
 - D the **humidity in the cell**.
 - E the **Fan speed**.
- 5 Go back using the **Arrow** key (to exit without saving) or touch the **Save** button (to save the entered values and exit).
- 6 Start the cycle by tapping the word **Start**.

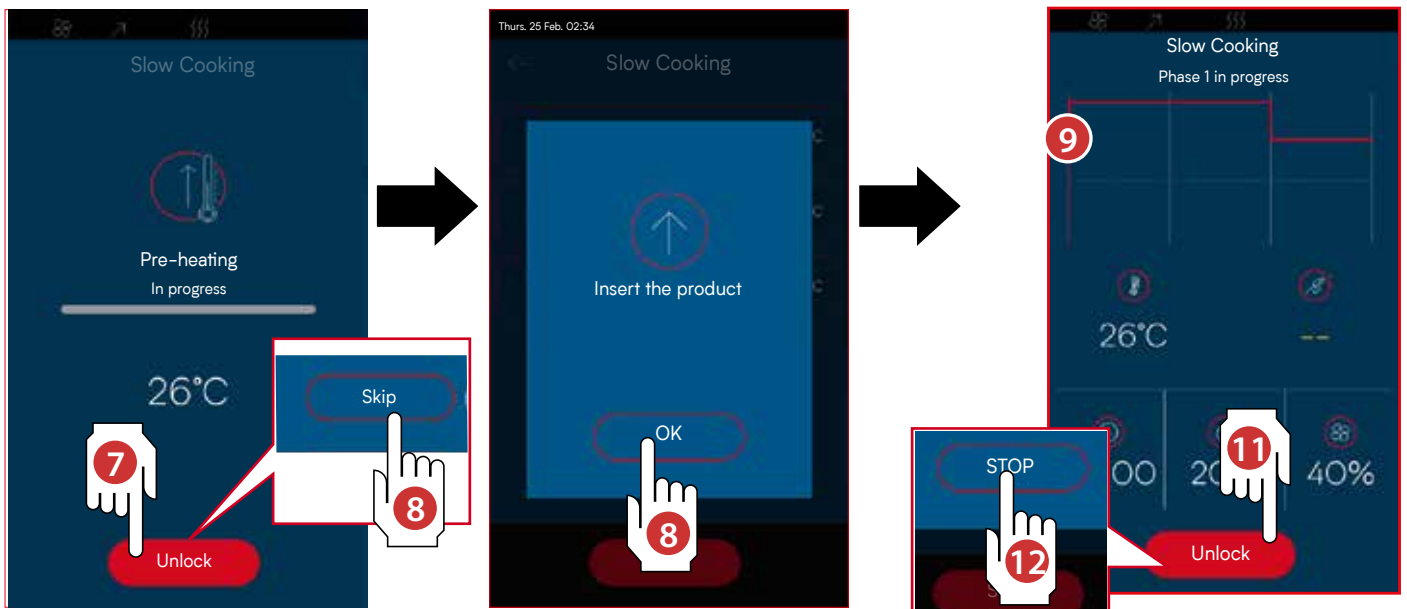

- 7 8** After touching **Start**, an automatic variable duration preheating of the chamber starts. If this is not required, press the **Release** button and then **Skip**.
- 9** When preheating has been completed, place the products to be cooked inside the cell and press **OK**. If the needle probe mode has been chosen, insert it in the food to be cooked (for further information on the needle probe, see p. 12)
- 10** The Slow cooking cycle is in progress. If this mode has been selected:
 - Needle** ▶ by setting a time: the cycle ends when the set time has elapsed.
 - Needle** ▶ using the needle probe: the cycle ends when a pre-set core temperature is reached.
- 11 12** To stop the cycle early, press the **Unblock** button and then **Stop**.

At the end of the slow cooking cycle, **a maintaining phase** of the products starts automatically (its parameters can be modified like a normal phase) to keep them at temperature until they are removed, which must take place in the shortest time possible.

SLOW LOW HUMIDITY COOKING

Some types of foods require particularly delicate cooking processes, with low humidity. The navigation is the same as for **slow cooking**, without the possibility of managing the **humidity in the cell** (point **D**).

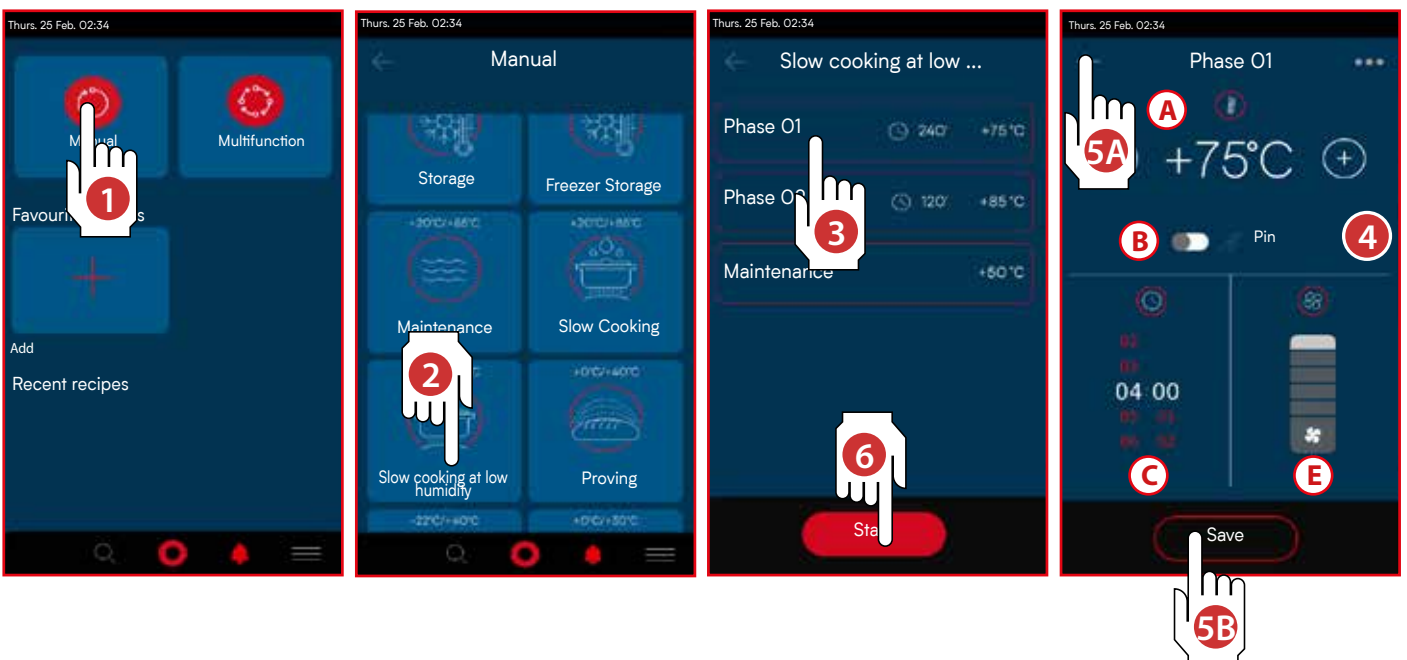

PASTEURISATION

The **Pasteurisation function** is used to sterilise sauces, creams or liquids with heat.



- 1 Tap the word **Manual**.
- 2 Select the word **Pasteurisation**;
- 3 If changes to phases 01...05 or to the final preservation phase are necessary, tap the phase to be changed (in the example Phase 01).

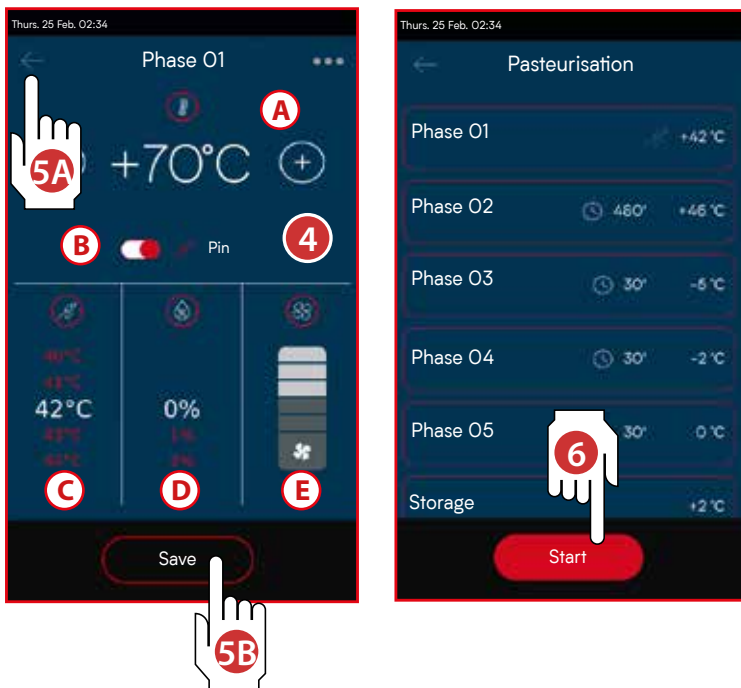

- 4 Set:
 - A the **temperature to be reached**.
 - B if working:
 - Needle ► by setting a time: the cycle ends when the set time has elapsed.
 - Needle ► using the needle probe: the cycle ends when a predetermined core temperature is reached (it is therefore necessary to insert the needle probe in the food to be blast chilled).

Note: some phases can be set by time, others with a needle probe.

 - C the **Duration** of the cycle (if a timed cycle has been chosen) or the **Needle probe temperature** (if a cycle with a probe has been chosen)
 - D the **humidity in the cell**.
 - E the **Fan speed**.
- 5 Go back using the **Arrow** key (to exit without saving) or touch the **Save** button (to save the entered values and exit).
- 6 Start the cycle by tapping the word **Start**.

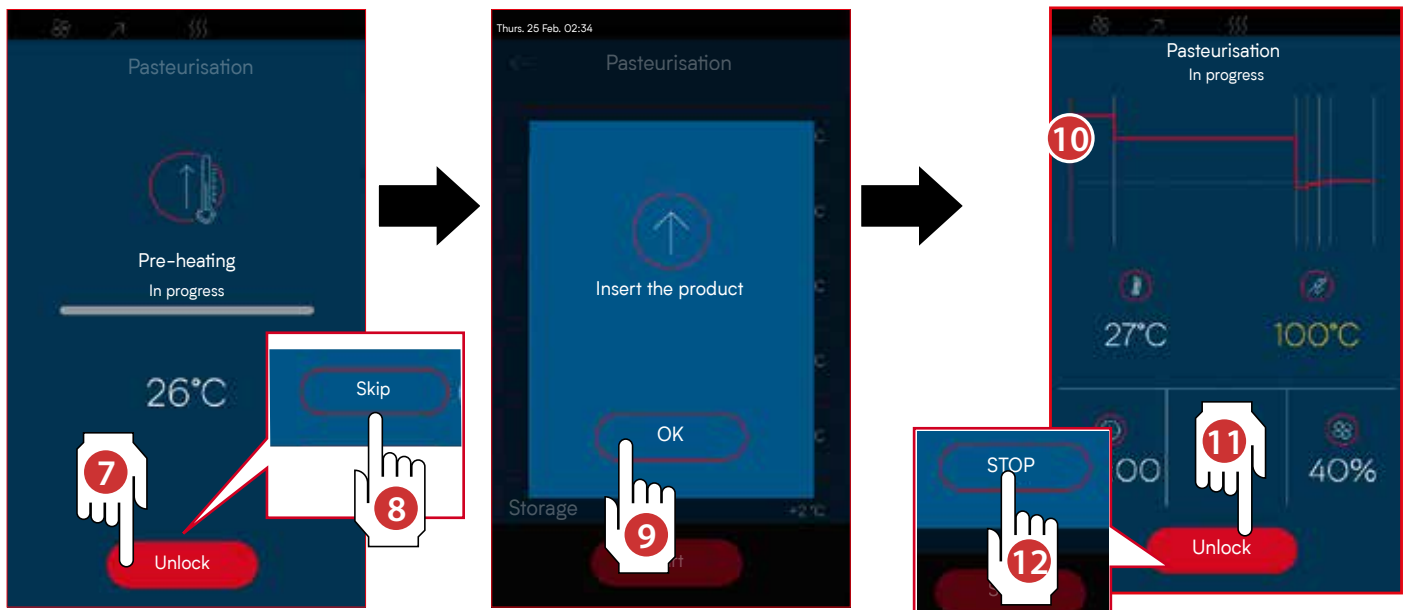

- 7 8** After touching **Start**, an automatic variable duration preheating of the chamber starts. If this is not required, press the **Release** button and then **Skip**.
- 9** When preheating has been completed, place the products to be pasteurised inside the cell and press **OK**. If the needle probe mode has been chosen, insert it into the food to be processed (for further information on the needle probe, see p. 12)
- 10** The Pasteurisation cycle is in progress. If this mode has been selected:
- Needle** ► *by setting a time: the cycle ends when the set time has elapsed.*
 - Needle** ► *using the needle probe: the cycle ends when a pre-set core temperature is reached.*
- 11 12** To stop the cycle early, press the **Unblock** button and then **Stop**.

At the end of the pasteurisation cycle, **a preservation** phase of the products begins automatically (its parameters can be modified like a normal phase) to keep them at temperature until their removal, which must take place in the shortest time possible.

CRYSTALLISATION

The tempering or crystallisation of chocolate is a widely used technique in the processing of chocolate: it causes cocoa butter to crystallise correctly, thus obtaining a soft final product with a shiny appearance, without the typical white patina that can sometimes be seen on the surface of chocolate.



- 1 Tap the word **Manual**.
- 2 Select the word **Crystallisation**.
- 3 If changes to phases 01 or to the final maintaining phase are necessary, tap the phase to be changed (in the example Phase 01).

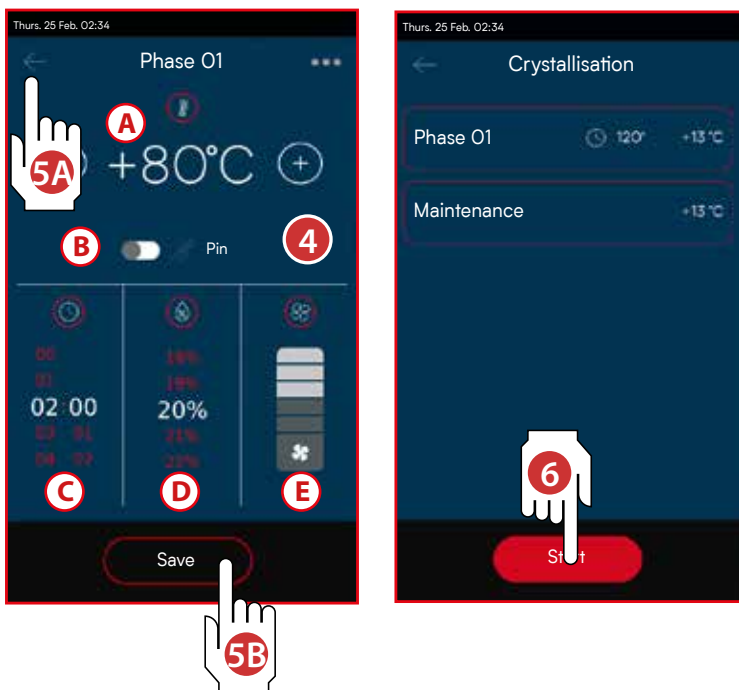

- 4 Set:
 - A the **temperature to be reached**.
 - B if working:
 - Needle** ► by setting a time: the cycle ends when the set time has elapsed.
 - Needle** ► using the needle probe: the cycle ends when a predetermined core temperature is reached (it is therefore necessary to insert the needle probe in the food to be blast chilled).

Note: some phases can be set by time, others with a needle probe.

 - C the **Duration** of the cycle (if a timed cycle has been chosen) or the **Needle probe temperature** (if a cycle with a probe has been chosen)
 - D the **humidity in the cell**.
 - E the **Fan speed**.
- 5 Go back using the **Arrow** key (to exit without saving) or touch the **Save** button (to save the entered values and exit).
- 6 Start the cycle by tapping the word **Start**.

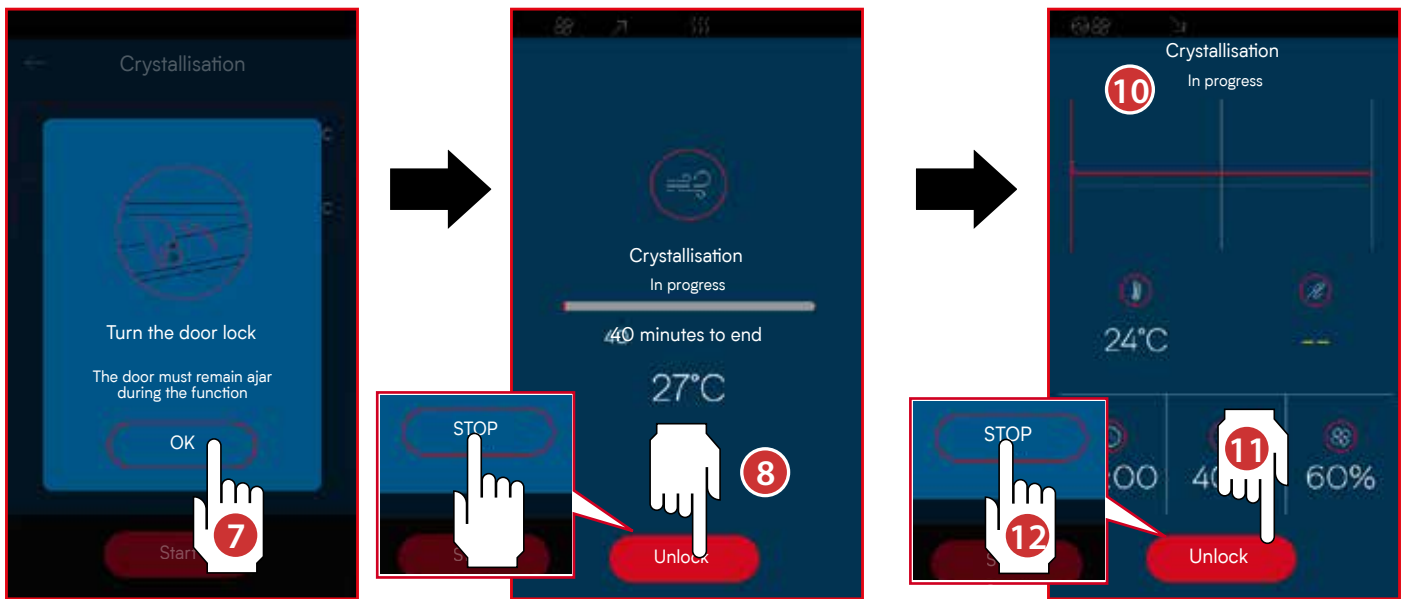

- 7 After tapping the word **Start** a screen warns that the door must remain ajar, by turning the door lock.
- 8 A chamber variable duration **drying** phase then begins. If not necessary, touch the **Unblock** button and then **Stop**.
- 9 Introduce the products to be crystallised inside the cell. If the needle probe mode has been chosen, insert it into the food to be processed (for further information on the needle probe, see p. 12)
- 10 The Pasteurisation cycle is in progress. If this mode has been selected:
 - Needle* ▶ **by setting a time**: the cycle ends when the set time has elapsed.
 - Needle* ▶ **using the needle probe**: the cycle ends when a pre-set core temperature is reached.
- 11 12 To stop the cycle early, press the **Unblock** button and then **Stop**.

At the end of the crystallisation **cycle, a products maintaining phase** begins automatically (its parameters can be modified like a normal phase) to keep them at temperature until their removal, which must take place in the shortest time possible.

MELTING CHOCOLATE

Chocolate is easily altered by heat because its main ingredients, cocoa and sugar, are mixed with cocoa butter which melts at a temperature of 38-40°C; if this threshold is exceeded, the structure is irreversibly altered.

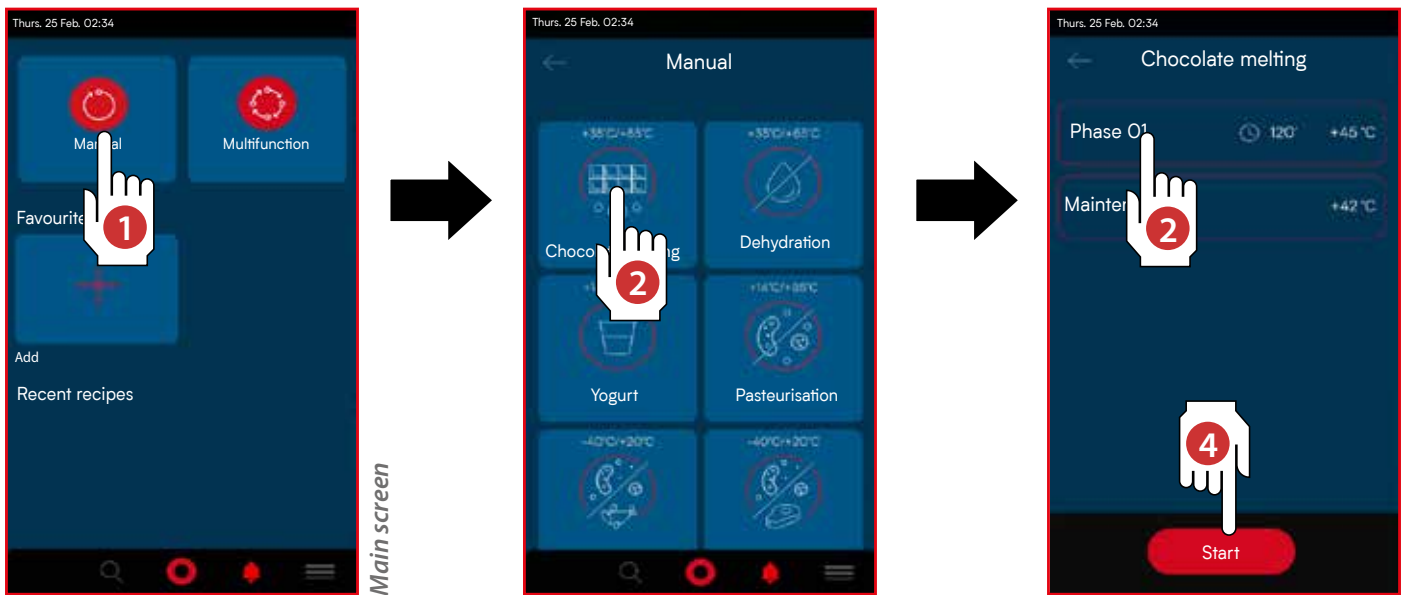

- 1 Tap the word **Manual**.
- 2 Select the words **Chocolate melting**.
- 3 If changes to phase 01 or to the final maintaining phase are necessary, tap the phase to be changed (in the example Phase 01).

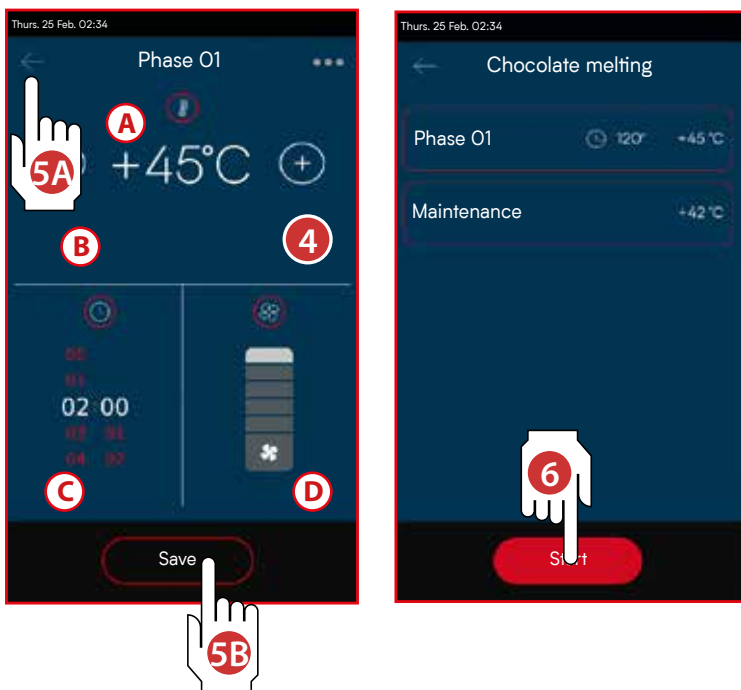

- 4 Set:
 - A the **temperature to be reached**.
 - B if working:
 - Needle** ► by setting a time: the cycle ends when the set time has elapsed.
 - Needle** ► using the needle probe: the cycle ends when a predetermined core temperature is reached (it is therefore necessary to insert the needle probe in the food to be blast chilled).
 - Note: some phases can be set by time, others with a needle probe.
 - C the **Duration** of the cycle (if a timed cycle has been chosen) or the **Needle probe temperature** (if a cycle with a probe has been chosen)
 - D the **Fan speed**.
- 5 Go back using the **Arrow** key (to exit without saving) or touch the **Save** button (to save the entered values and exit).
- 6 Start the cycle by tapping the word **Start**.

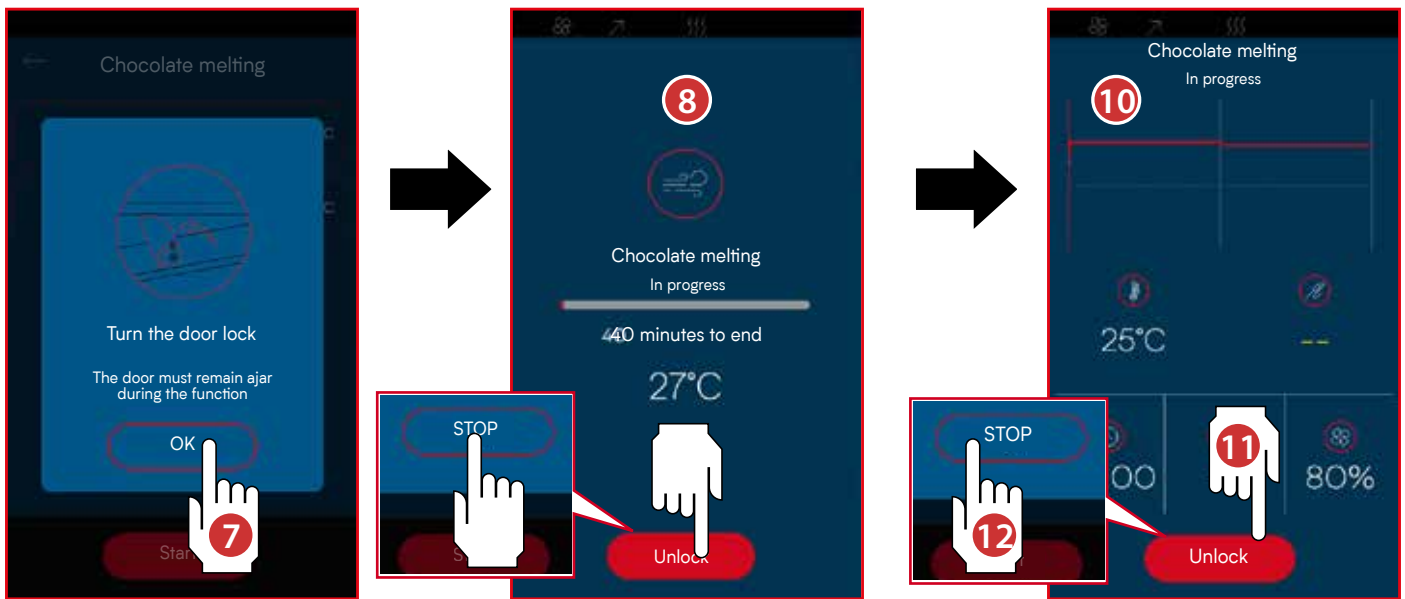

- 7** After tapping the word **Start** a screen warns that the door must remain ajar, by turning the door lock.
- 8** A chamber variable duration **drying** phase then begins. If not necessary, touch the **Unblock** button and then **Stop**.
- 9** Introduce the products to be crystallised inside the cell. If the needle probe mode has been chosen, insert it into the food to be processed (for further information on the needle probe, see p. 12)
- 10** The Pasteurisation cycle is in progress. If this mode has been selected:
 - Needle** ▶ *by setting a time: the cycle ends when the set time has elapsed.*
 - Needle** ▶ *using the needle probe: the cycle ends when a pre-set core temperature is reached.*
- 11 12** To stop the cycle early, press the **Unblock** button and then **Stop**.

At the end of the cycle, **a maintaining phase** of the products starts automatically (its parameters can be modified like a normal phase) to keep them at temperature until they are removed, which must take place in the shortest time possible.

DEHYDRATION

Dehydration consists of eliminating water from food, in order to avoid the proliferation of moulds and bacteria, which in the water would find a suitable environment to develop. The sun drying process has been known since ancient times to prepare it for the winter and is an excellent method of preservation because it minimally alters the mineral and protein content and, at the same time, enhances the flavour compared to fresh foods.

The ideal dehydration **temperature** varies depending on the quantity of water contained in the food and the consistency of its pulp; indicatively, a temperature of 40°C can be considered optimal for most foods.

A very low dehydration temperature takes longer, however it better preserves the nutritional and aesthetic properties of the food.

The **duration** of dehydration depends on the temperature set and the type of food; fruit on average requires much longer dehydration times (24-36 hours) than vegetables (4-8 hours) or plants and aromatic herbs (3-5 hours).

The times are considerably reduced if fruit and vegetables are cut into small pieces, or into thin slices with a maximum thickness of 10 mm. The food to be dehydrated must be perfectly clean, ripe and not bruised; once dehydrated. It must be closed in sterile and airtight containers, to prevent food from reabsorbing moisture from the environment.



- 1 Tap the word **Manual**.
- 2 Select the word **Dehydration**.
- 3 If changes to phase 01 or to the final maintaining phase are necessary, tap the phase to be changed (in the example Phase 01).



- 4 Set:
 - A the **temperature to be reached**.
 - B if working:
 - Needle ► by setting a time: the cycle ends when the set time has elapsed.
 - Needle ► using the needle probe: the cycle ends when a predetermined core temperature is reached (it is therefore necessary to insert the needle probe in the food to be blast chilled).
- Note: some phases can be set by time, others with a needle probe.
- C the **Duration** of the cycle (if a timed cycle has been chosen) or the **Needle probe temperature** (if a cycle with a probe has been chosen)
- D the **Fan speed**.
- 5 Go back using the **Arrow** key (to exit without saving) or touch the **Save** button (to save the entered values and exit).
- 6 Start the cycle by tapping the word **Start**.

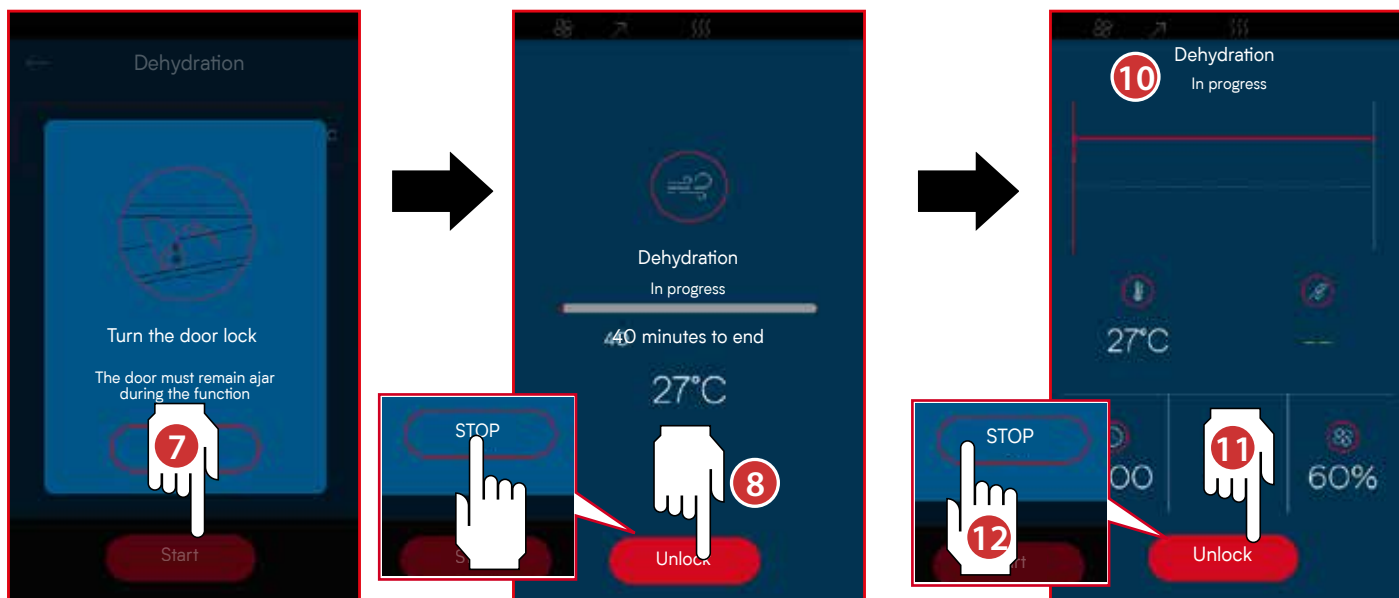

- 7** After tapping the word **Start** a screen warns that the door must remain ajar, by turning the door lock.
- 8** A chamber variable duration **drying** phase then begins. If not necessary, touch the **Unblock** button and then **Stop**.
- 9** Insert the products to be dehydrated inside the cell. If the needle probe mode has been chosen, insert it into the food to be processed (for further information on the needle probe, see p. 12)
- 10** The Dehydration cycle is in progress. If this mode has been selected:
 - Needle** ▶ *by setting a time: the cycle ends when the set time has elapsed.*
 - Needle** ▶ *using the needle probe: the cycle ends when a pre-set core temperature is reached.*
- 11 12** To stop the cycle early, press the **Unblock** button and then **Stop**.

YOGHURT

This equipment is able to maintain a constant and optimal temperature so that milk can be transformed into yoghurt by fermenting the lactobacilli *Lactobacillus termophilus* and *Streptococcus bulgaricus* added to it.

To prepare the initial mix, only two ingredients are required:

- a **litre of cow's milk**, preferably whole to give more creaminess to the final product; if it is not pasteurised or treated with UHT systems, it must be boiled in advance to eliminate any bacteria and left to cool to room temperature before adding the lactic ferments; partially skimmed, skimmed milk or vegetable drinks (e.g. soya- or rice-based) are usable but could result in a very liquid yoghurt as they are usually low in fat.
- **lactic ferments** (*Lactobacillus termophilus* and *Streptococcus*): they are readily available, freeze-dried, in pharmacies, organic food stores, herbalists, on the Internet. Alternatively, it is possible to use a 125g jar of natural white yoghurt that has a very long expiry date (at least 20-30 days): this guarantees that the enzymes contained in it are still vital and active.

Pour the sachet of freeze-dried enzymes or the contents of the jar of natural white yoghurt into the litre of milk at room temperature; with a wooden ladle, mix the mixture gently and for a long time.

Pour the mixture into a plastic or glass container; close the container and place it in the appliance.

Set the temperature from **38 to 44°C**, the ideal temperature for fermentation.

Wait at least **4-6 hours** without moving or shaking the pot, then check if the yoghurt has formed by slightly shaking the container: the consistency should no longer be liquid, but rather gelatinous, similar to that of a pudding. As it cools, the yoghurt will firm up even more. If it has not yet formed, wait another hour and repeat the check; be careful, overly long fermentation times produce a very acidic yoghurt.

Then put the container in the refrigerator for at least 4-6 hours, until it has completely cooled and matured. Being a completely natural product, it should ideally be consumed within about 4-5 days at most.

To prepare additional yoghurt it will no longer be necessary to buy lactic ferments, instead simply mix three or four tablespoons of previously self-produced yoghurt (to which sugar, fruit or other flavourings must not have been added) to a litre of whole milk.



- 1 Tap the word **Manual**.
- 2 Select the word **Yoghurt**.
- 3 If changes to phases O1....O5 or to the final preservation phase are necessary, tap the phase to be changed (in the example Phase O1).

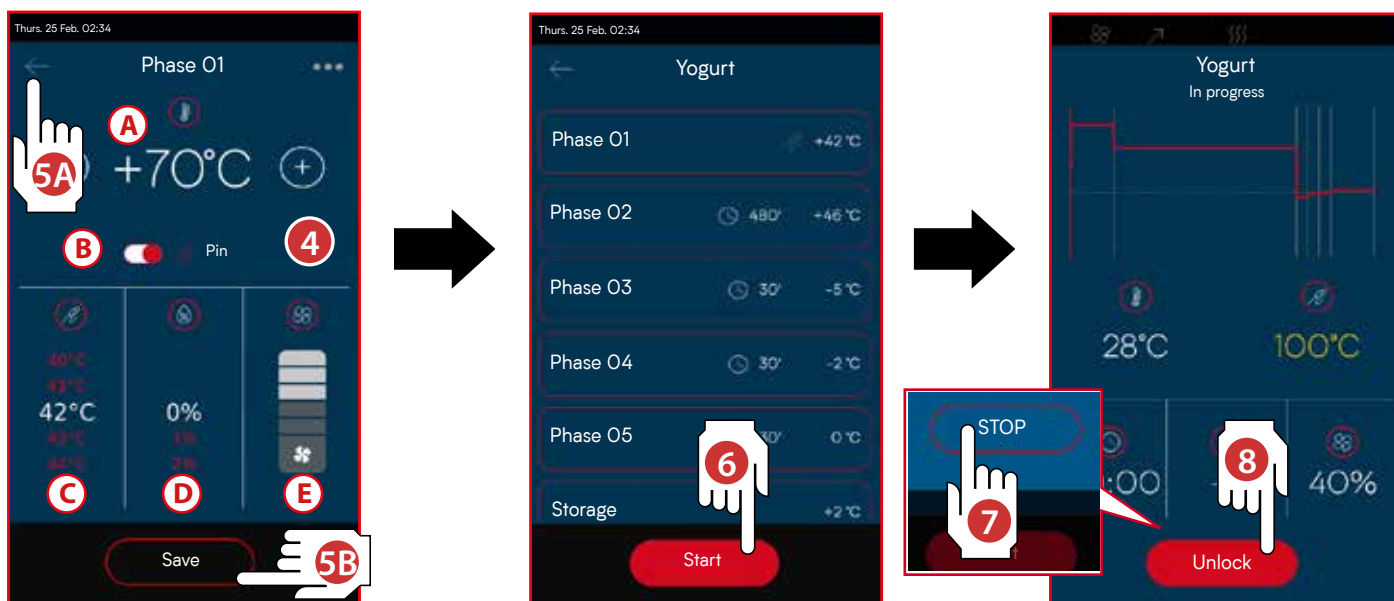

4 Set:

A the **temperature to be reached**.

B if working:

Needle ► **by setting a time: the cycle ends when the set time has elapsed.**

Needle ► **using the needle probe: the cycle ends when a predetermined core temperature is reached (it is therefore necessary to insert the needle probe in the food to be blast chilled).**

Note: some phases can be set by time, others with a needle probe.

C the **Duration** of the cycle (if a timed cycle has been chosen) or the **Needle probe temperature** (if a cycle with a probe has been chosen)

D the **humidity in the cell**.

E the **Fan speed**.

5 Go back using the **Arrow** key (to exit without saving) or touch the **Save** button (to save the entered values and exit).

6 Start the cycle by tapping the word **Start**.

7 8 To stop the cycle early, press the **Unblock** button and then **Stop**.

At the end of the cycle a **preservation phase** of the products starts automatically (its parameters can be modified like a normal phase) to keep them at temperature until they are removed, which must take place in the shortest time possible.

ANISAKIS-KILLER | TENIA KILLER

The functions serve to eliminate the risks associated with the contamination of products by pathogens such as anisakis and tapeworm, ensuring maximum effectiveness in terms of food hygiene.



- 1 Tap the word **Manual**.
- 2 Select the words **Anisakis killer** or **Tenia killer**
- 3 Start the cycle by touching the word **Start**;
- 4 The **Anisakis-Tenia killer**; cycle will then start; to block the function in advance, press the **Unlock** button and then **Stop**.

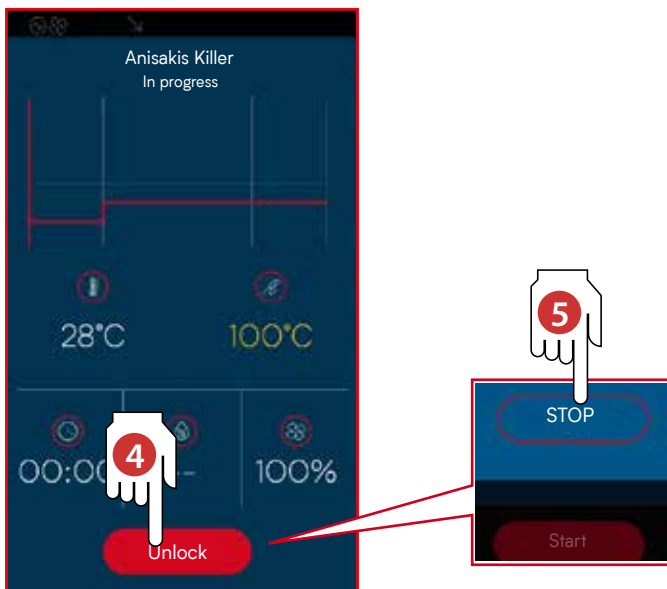

ANISAKIS

The larvae of *Anisakis Simplex* are parasites that could be present on fish products that are not sufficiently cooked or served raw: if the larvae penetrate the gastric mucosa they cause abdominal pain and in severe cases, serious complications. The cycle includes an initial deep freezing phase at the end of which a 24-hour maintaining phase (imposed by the rules for treating fish against anisakis) starts automatically.



In the case of fish products, especially if they are eaten raw or not cooked for a long time, it is necessary to perform negative blast chilling before consumption to avoid health risks linked to bacterial and parasitic contamination, in particular the *Anisakis simplex* larvae. If the larvae penetrate the gastric mucosa they cause violent abdominal pain, related to nausea and vomiting. In this case, one or two weeks after the infection, they work their way to the intestine and can cause a serious immunity response, accompanied by intermittent abdominal pain, nausea, diarrhoea and fever or intestinal perforation.

PRE-COOLING

The function is useful if large quantities of food or large-sized foods need to be blast chilled, in fact it cools the appliance cell before introducing the food to be blast chilled or deep frozen.

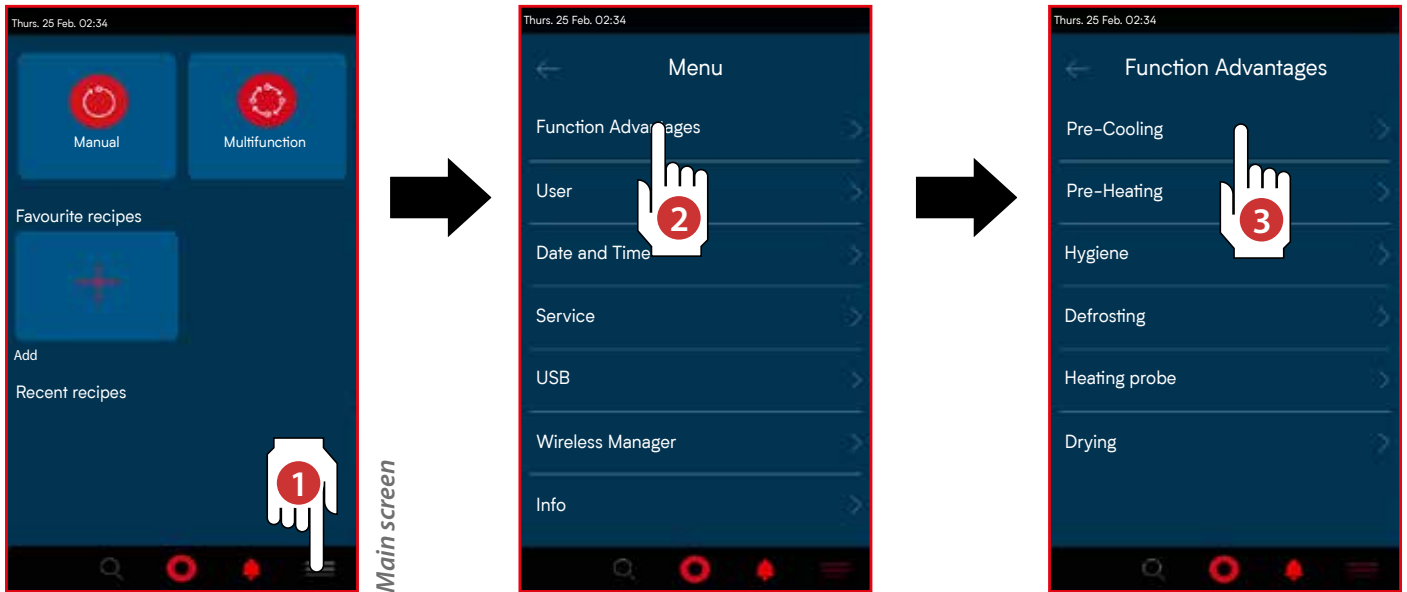

- 1 Tap the icon
- 2 Select **Plus Functions**
- 3 Select **Precooling**: the function starts.

Pre-cooling ends:

- when the expected temperature is reached;
- **4 5** press **Release** and then **Stop**.

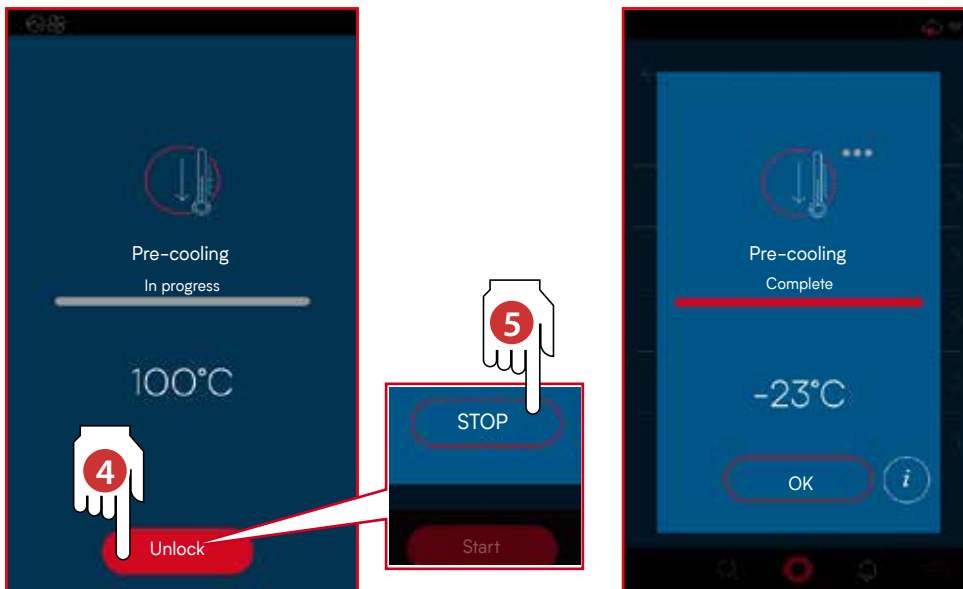

- 6 When **Precooling** has been completed, the "**completed**" message appears. After reaching the pre-cooling temperature, the equipment maintains the temperature until the door is opened.

PREHEATING

The function is useful for preheating the cell before starting the slow cooking function.

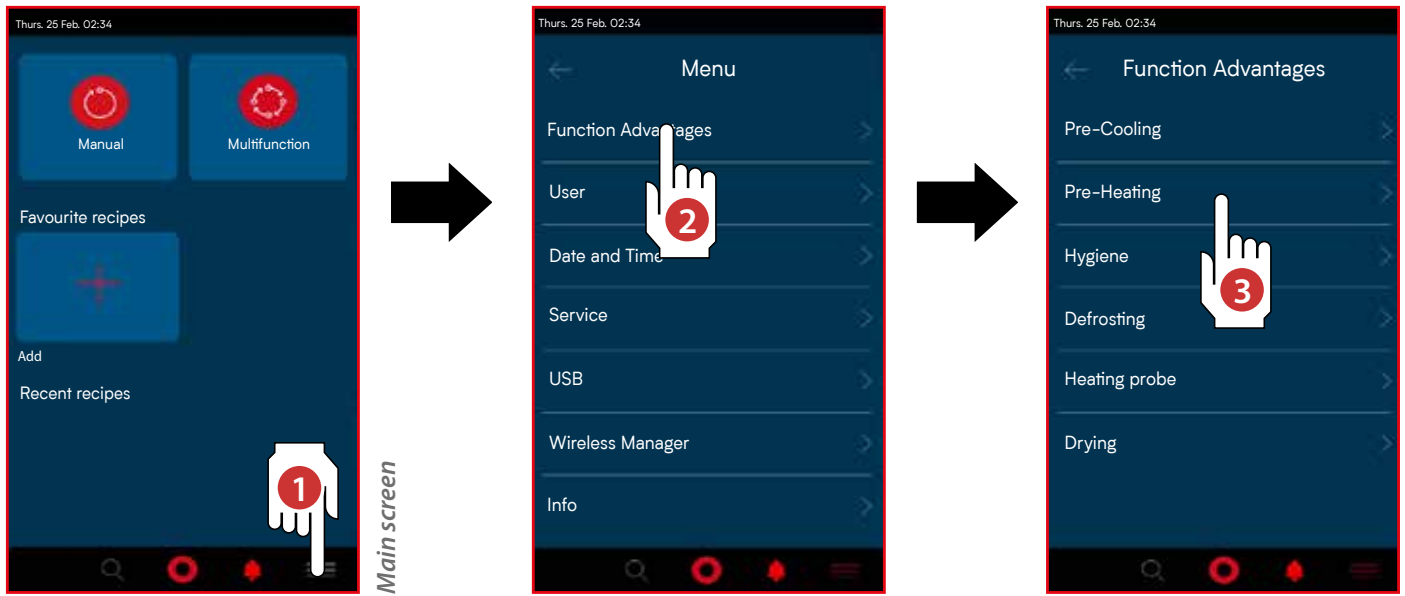

- 1 Tap the icon
- 2 Select **Plus Functions**
- 3 Select **Preheating**: the function starts.

Preheating ends:

- when the expected temperature is reached;
- **4 5** press **Release** and then **Stop**.

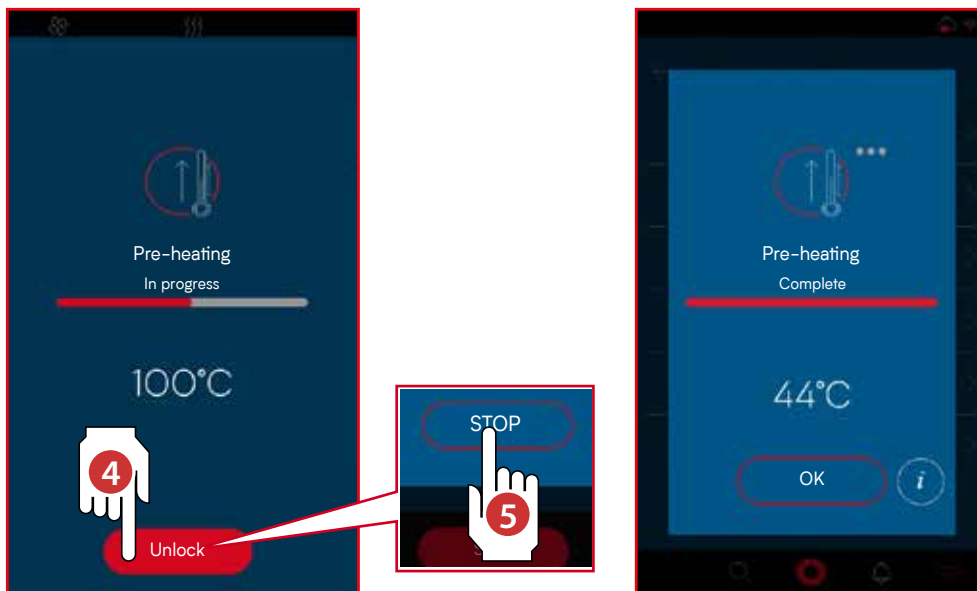

- 6 When **Preheating** has been completed, the **"completed"** message appears. After reaching the pre-cooling temperature, the equipment maintains the temperature until the door is opened.

SPECIAL FUNCTIONS

HYGIENE

Sterilisation can only start if the chamber temperature is above 15°C and keeping the door closed. Sterilisation ends when the set time has elapsed (it cannot be set) or by pressing **Skip**. The display shows the time remaining until the end of sterilisation. At the end, the wording "**Cycle completed**" appears, tap the word to exit. Opening of the door or a power failure interrupts sterilisation.

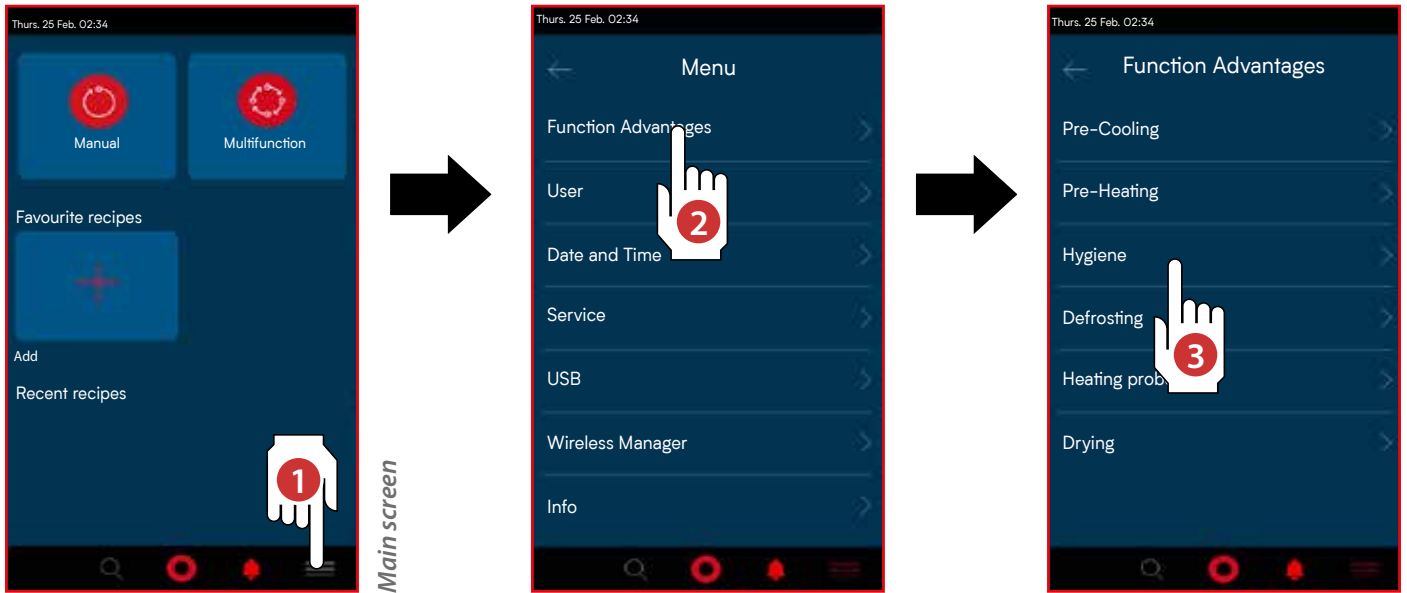

- 1 Tap the icon ≡
- 2 Select **Plus Functions**
- 3 Select **Hygiene**: the function starts.
- 4 After 30 minutes, a pop-up window indicates that the door must be opened. Open the door and confirm with **OK**: a 1-minute countdown starts, during which the fans are switched on and the air in the room is renewed.

Sterilisation ends:

- at the end of the intended phases;
- 5 6 press **Release** and then **Stop**.
- 7 When the **Sterilisation** has been completed successfully, the "**completed**" message appears.

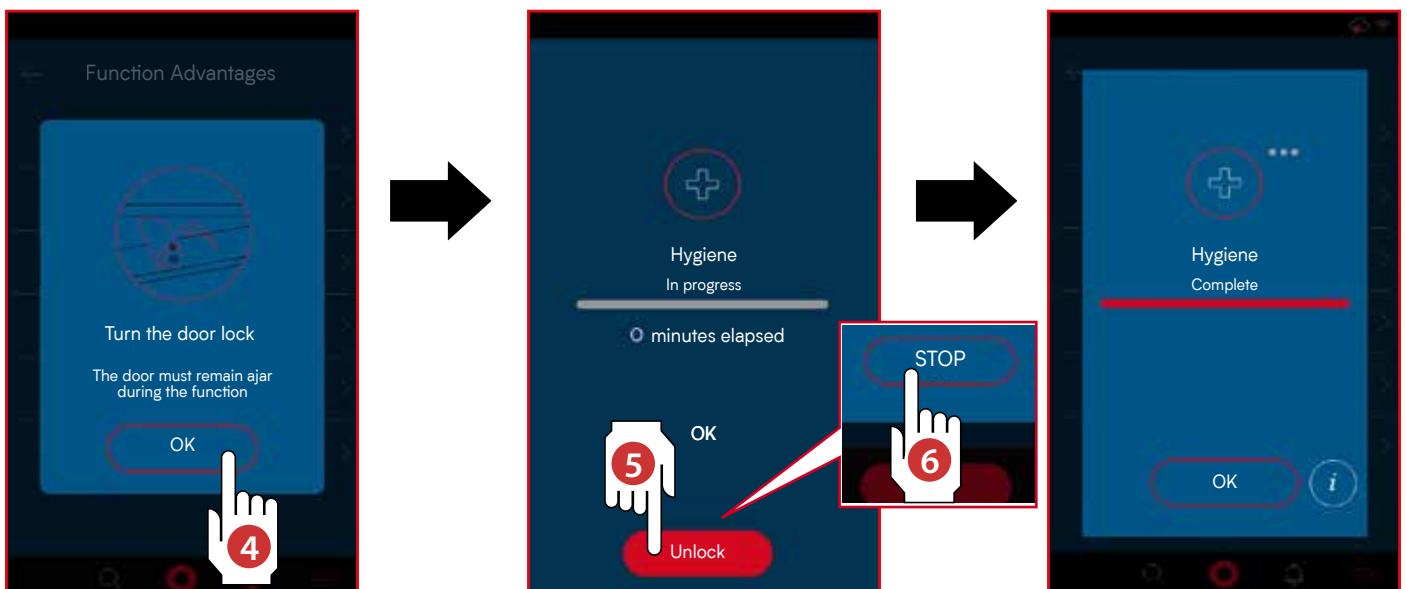

DEFROST

To activate the defrost, tap the **Defrost** icon, the cycle starts immediately.

Defrosting will be activated automatically in all the preservation cycles, with the product inserted; once the defrost is finished, the machine will resume working normally. Defrosting can only start if the evaporator temperature is below 3°C

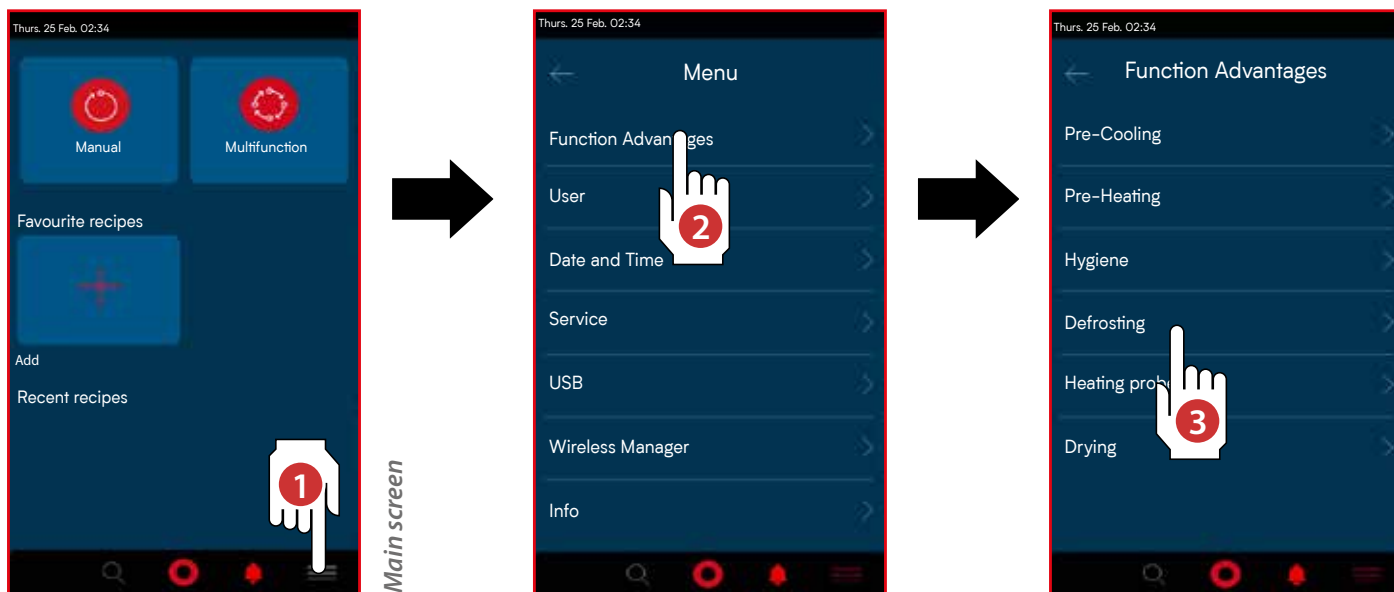

- 1 Tap the icon ≡
- 2 Touch **Plus Functions**
- 3 Select **Defrost**: the function starts.

Defrost ends:

- upon reaching the envisaged time;
- 4 5 press **Release** and then **Stop**.

- 6 After successful **Defrosting**, the word "**completed**" appears

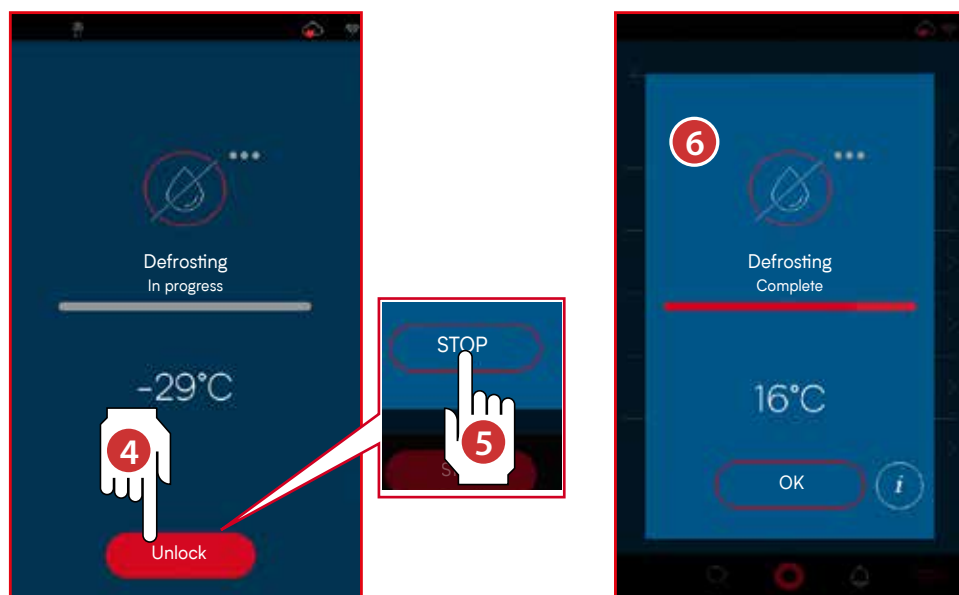

SPECIAL FUNCTIONS

NEEDLE PROBE HEATING

The function is useful for facilitating extraction of the needle from the product after a deep freezing cycle.

The needle probe can only be heated if its temperature is below -5°C.

The heating phase ends automatically after reaching the appropriate temperature for extraction from the product, simultaneously the wording "remove needle" appears, tap the wording to exit.



Main screen

- 1 Tap the icon
- 2 Select **Plus Functions**
- 3 Select **Needle probe heating**: the function starts.

Needle probe heating ends:

- upon reaching the envisaged time;
- **4 5** press **Release** and then **Stop**.

- 6 When the **Needle Probe** has been **heated** successfully, the "**completed**" message appears.

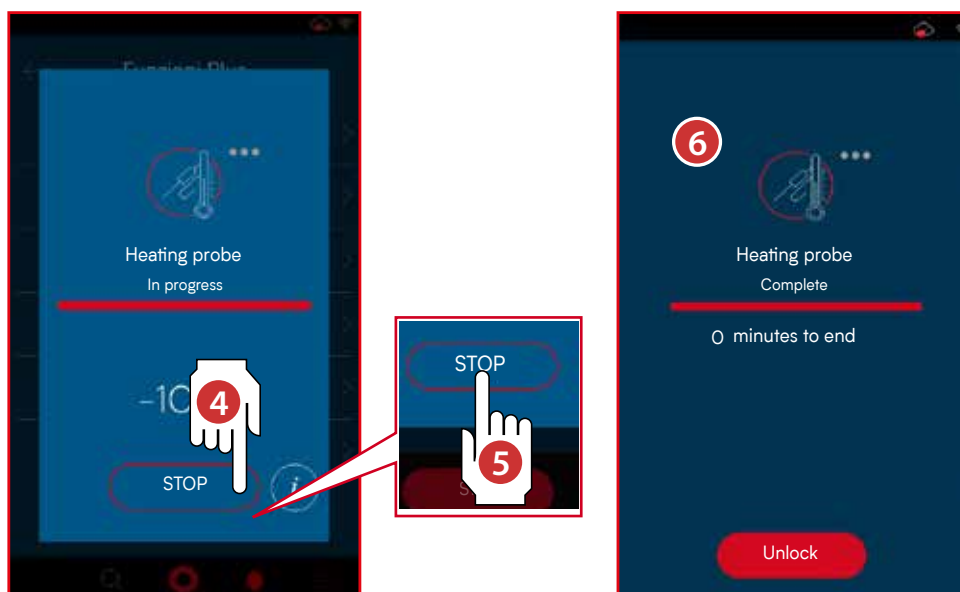

DRYING

The function is useful for drying of the cell after having performed a cold or hot cycle.

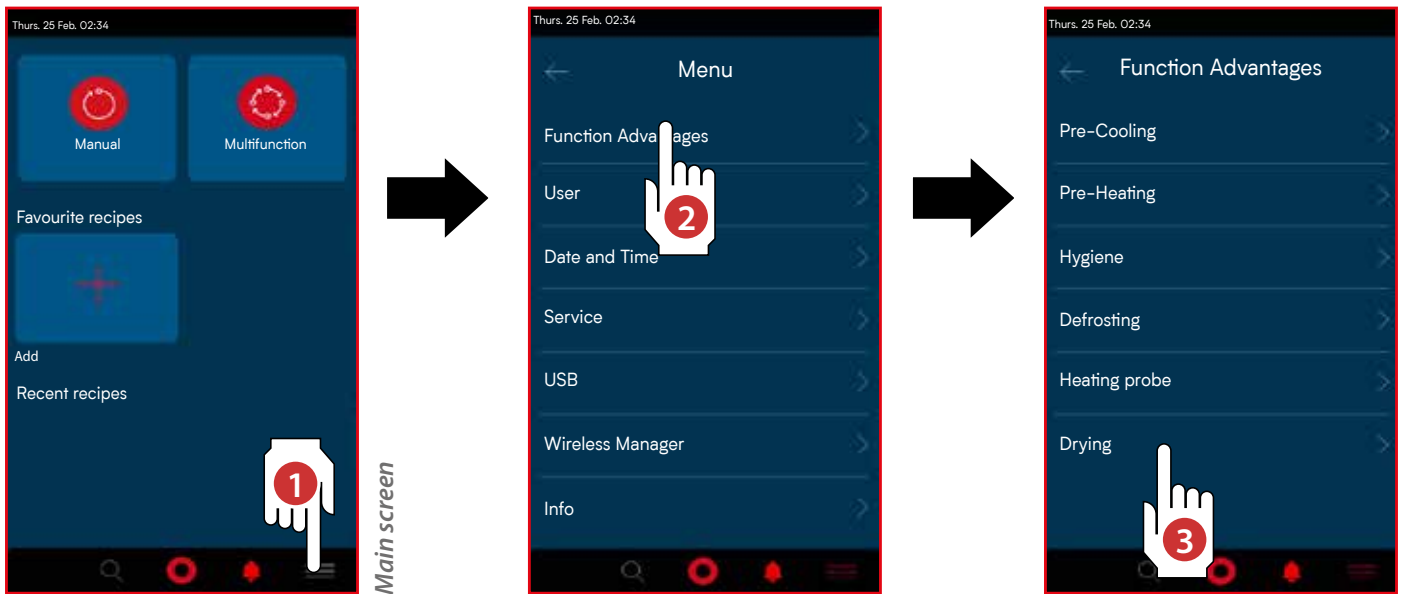

- 1 Tap the icon
- 2 Select **Plus Functions**
- 3 Select the word **Drying**
- 4 After tapping the word, a screen warns that the door must remain ajar, by turning the door lock.

After carrying out the operation, the **Drying** function starts and ends:

- upon reaching the envisaged time;
- 5 6 pressing the **Unlock** button and then **Stop**.

When the **Drying** process has been completed successfully, the "**completed**" message appears.



MULTIFUNCTION

This section contains recipes pre-set in the factory or saved by the user at the end of a cycle (e.g. a blast chilling cycle). The Manufacturer's recipes CANNOT be deleted or PERMANENTLY modified. Their parameters can only be modified for the cycle that will be performed (the modifications are not permanent and are deleted by exiting the program). The parameters can only be changed before the cycle starts, not during its execution. Alternatively, the recipe modified by the user can be stored with a different name.

Launch a recipe in the memory

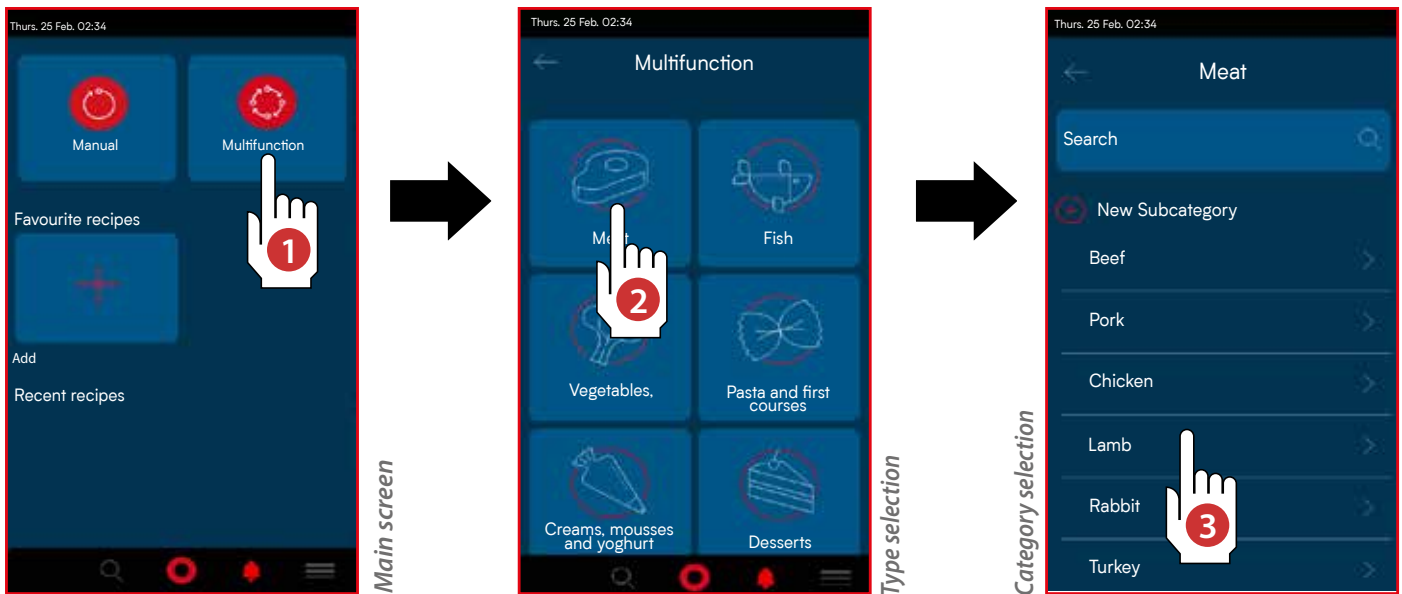

- 1 Tap the **Multifunction** icon
- 2 Select the **type** (e.g. meat)
- 3 Select the **category** (e.g. lamb)

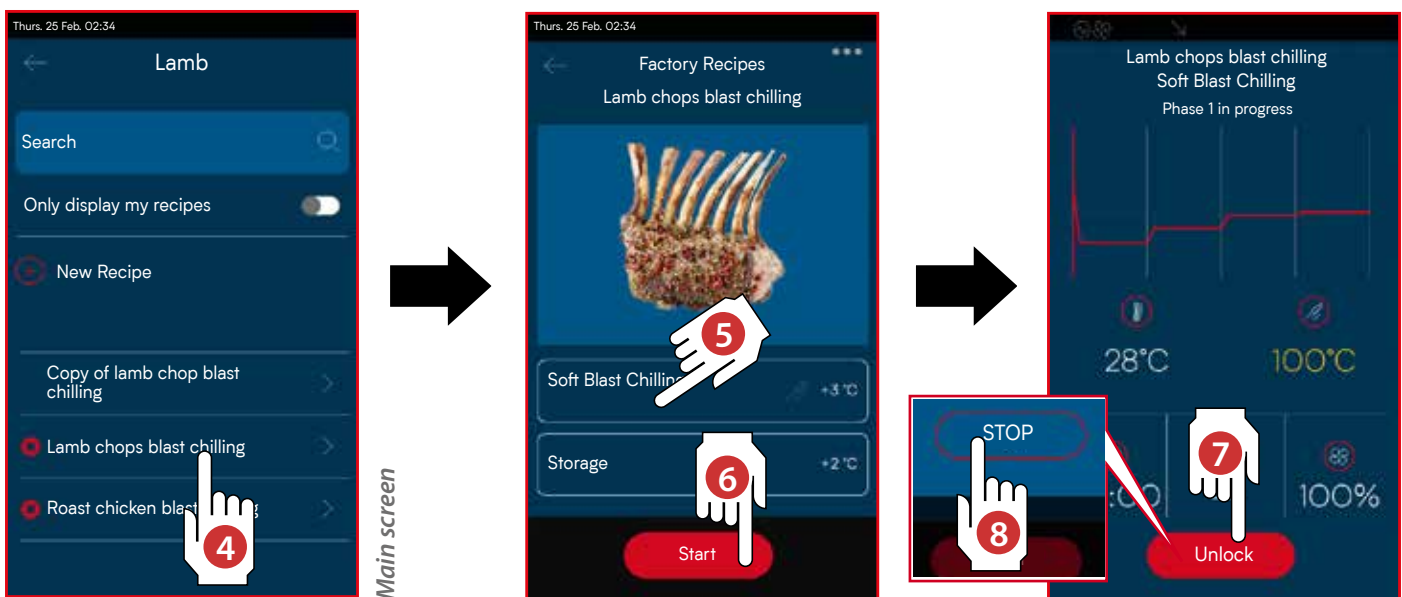

- 4 Select the **recipe** to be started (e.g. Blast chilling of lamb ribs); to facilitate the search, it is possible to filter the recipes by viewing only the user's personal recipes. The recipes preceded by the symbol  are factory pre-set recipes: they cannot be renamed or deleted.
- 5 If necessary, modify the phase of interest by proceeding as usual (see for example p. 16) or
- 6 start the recipe with the **Start** button.
- 7 8 To stop the cycle early, press the **Unlock** button and then **Stop**.

CREATE A NEW RECIPE

There are two ways to create a new recipe:

- A** by setting a new recipe;
- B** by duplicating a recipe already in memory.

A

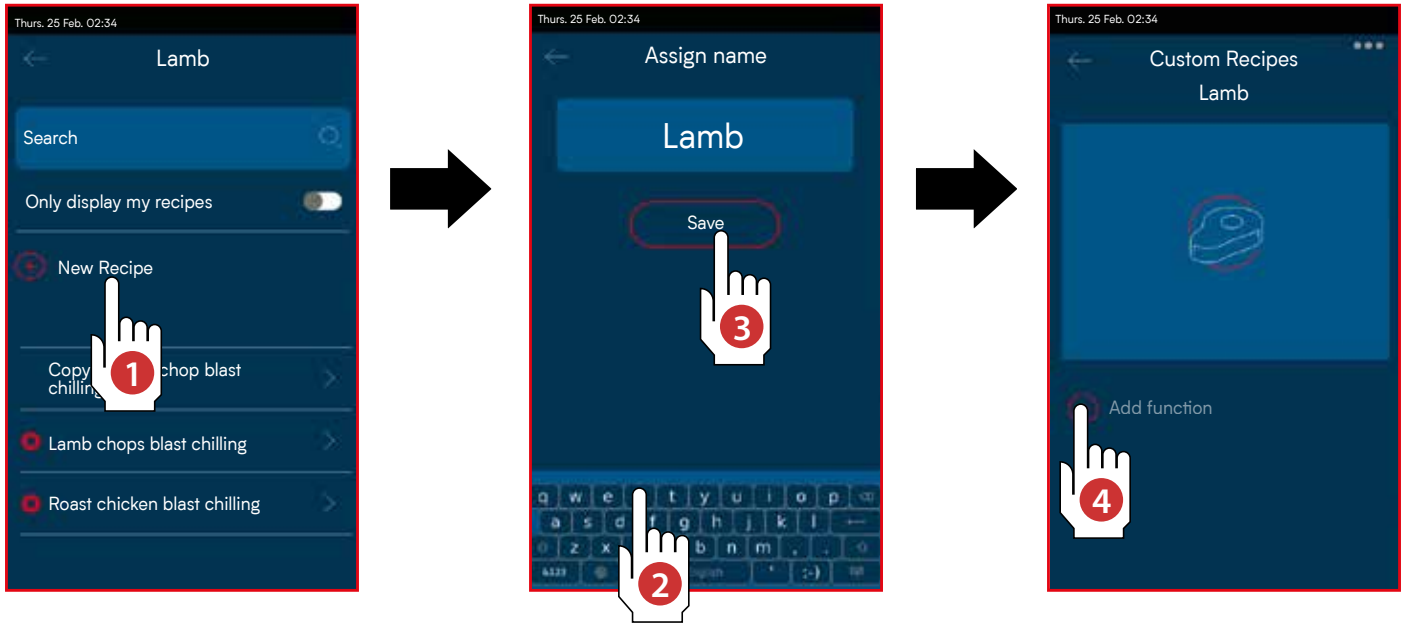

- 1** Choose the **type** and **category** of interest (e.g. Meat, Lamb). Tap the wording **New recipe** at the end of the recipes already in memory.
- 2** Enter the **name** of the new recipe (e.g. lamb with sage)
- 3** Save the **recipe** by tapping the **Save** key
- 4** Set the recipe parameters by tapping the words **Add a function**

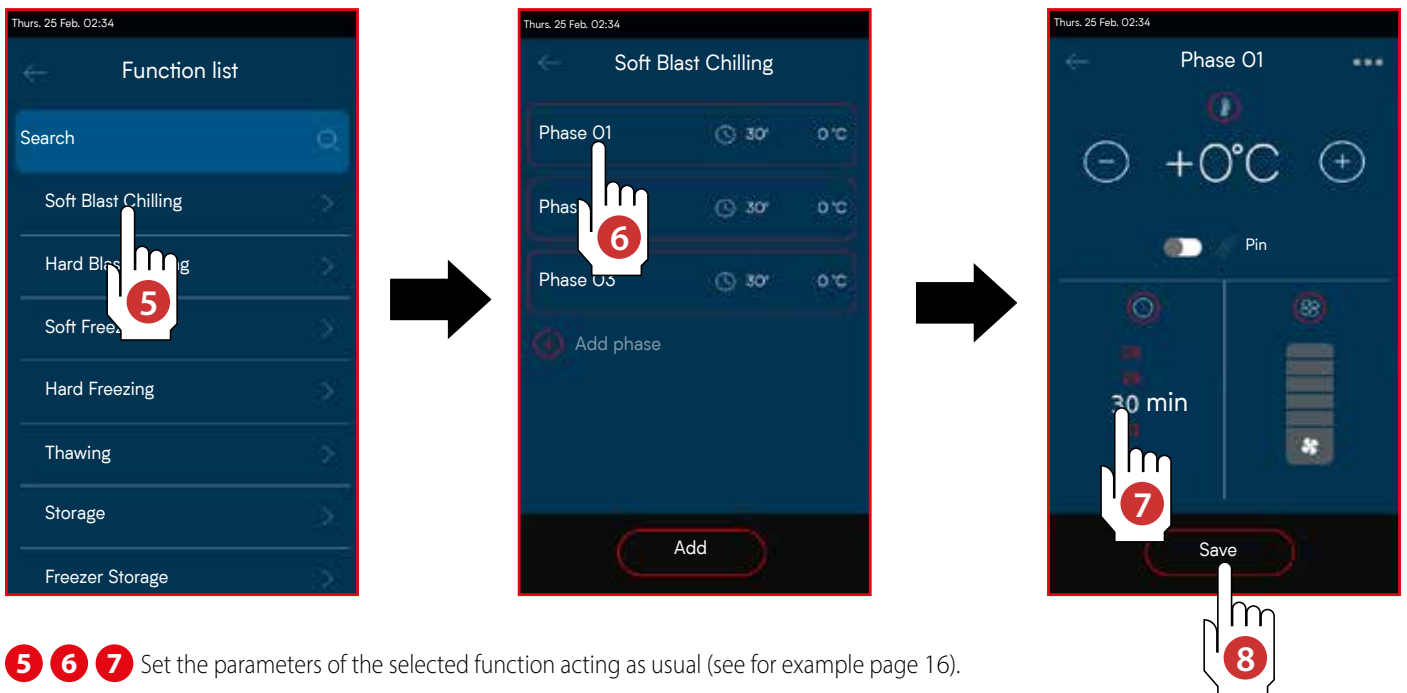

- 5 6 7** Set the parameters of the selected function acting as usual (see for example page 16).
- 8** Save the settings made.

MULTIFUNCTION

B

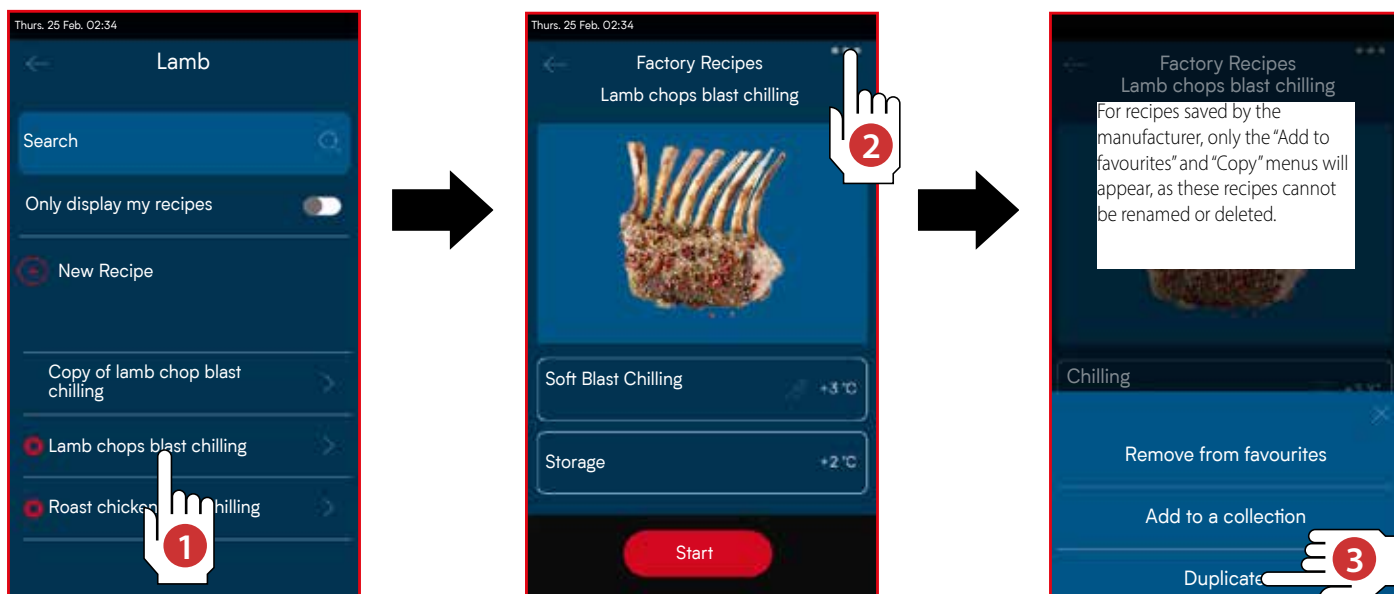

- 1** Choose a recipe **as similar as possible** to the one to be created (e.g. Meat, Lamb, Blast chilling of lamb ribs).
- 2** Tap the three dots in the top right;
- 3** Choose to **duplicate** the recipe.

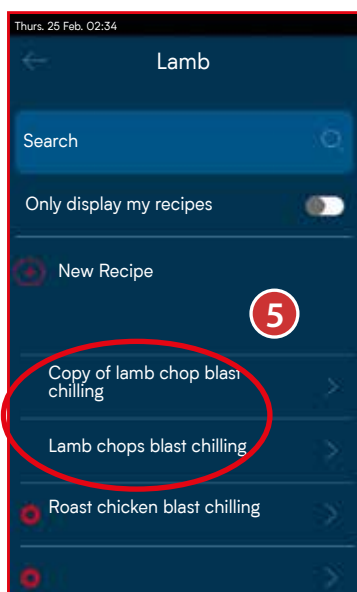

- 4** Proceeding as usual, make all the desired settings to adapt it to your requirements, for example add phases or modify those already present.

The duplicate recipe will be placed in the same list (in the example Meat, Lamb).

In the list you will now find two recipes:

- the original factory recipe (cannot be deleted or renamed) ▶  Blast chilling of lamb ribs
- **5** the recipe modified by the user (can be deleted and renamed) ▶ Copy of Lamb chops blast chilling

If desired, it is possible to rename the personal recipe, see p. 49.

DELETE | RENAME A RECIPE | SAVE IT AS A FAVOURITE

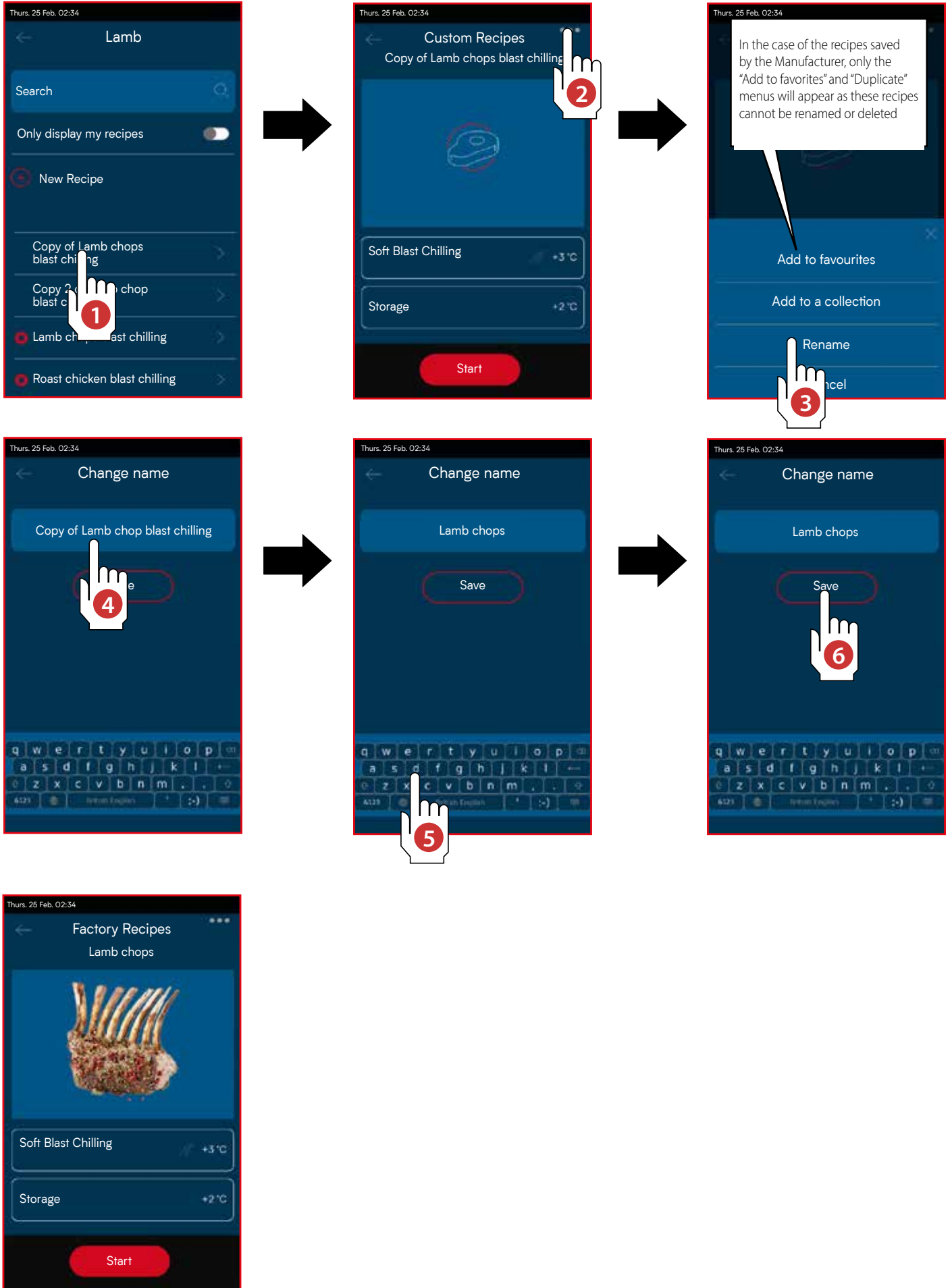

MULTIFUNCTION

MAINTENANCE



BEFORE CARRYING OUT ANY MAINTENANCE INTERVENTION, IT IS NECESSARY TO DISCONNECT THE ELECTRICAL SOURCE OF THE EQUIPMENT AND WEAR ADEQUATE PERSONAL PROTECTIVE DEVICES (EX. GLOVES, ETC...).



THE USER MUST CARRY OUT ONLY ROUTINE MAINTENANCE OPERATIONS (UNDERSTOOD AS CLEANING). IN CASE OF EXTRAORDINARY MAINTENANCE, ENTER IN CONTACT WITH AN ASSISTANCE CENTRE AND REQUEST THE INTERVENTION OF AN AUTHORISED TECHNICIAN.



THE WARRANTY WILL BE VOIDED IN CASE OF DAMAGES BY THE LACK OF OR INCORRECT MAINTENANCE (EX. USE OF UNSUITABLE DETERGENTS).

To clean any component or accessory DO NOT use:

- abrasive or powder detergents;
- aggressive or corrosive detergents (e.g. hydrochloric/muriatic or sulphuric acid, caustic soda, etc...). Attention! Do not use these substances, even to clean the pavement under the equipment;
- abrasive or sharp utensils (ex. abrasive sponges, scrapers, steel brushes, etc...);
- vapour or pressurised water jets.

Upon the first use wash the pans and the chamber with a cloth dampened with hot water and soap and end with rinsing and drying. To eliminate processing residues, run the appliance empty for approximately 30 minutes by selecting the **Slow Cooking** function.

CLEANING OF EXTERNAL STEEL SURFACES

If the **Slow Cooking function has been used**, wait for the appliance to cool down, then use a cloth soaked in hot soapy water or specific products for steel. Finish with rinsing and drying.

CLEANING THE EQUIPMENT CHAMBER

Clean the equipment chamber daily to ensure optimum hygiene levels and machine performance. Fat particles or food residues could also ignite when using the **Slow Cooking** function, causing damage to persons and to the appliance itself. Cleaning must always be carried out with the chamber cold: use a cloth soaked in hot soapy water and finish with rinsing and drying.

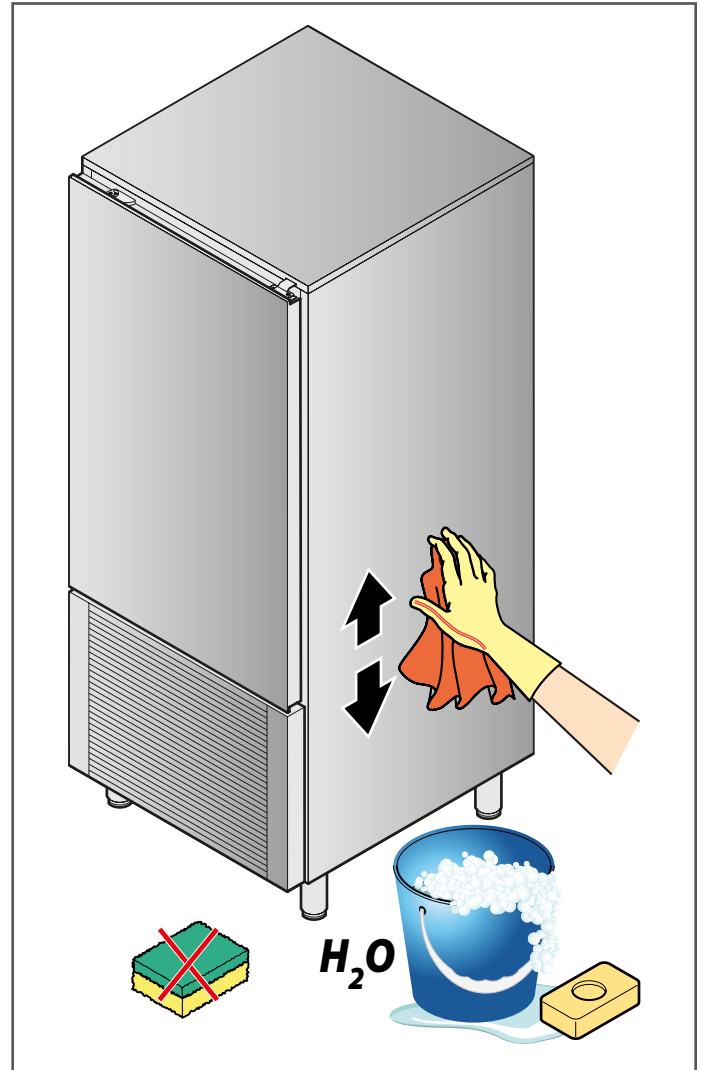

TOUCH SCREEN

If the **Slow Cooking function was used**, wait for the appliance to cool down, then use a cloth slightly dampened with a specific product for glass following the instructions of the detergent manufacturer. Do not spray too much product to prevent infiltrations that can damage the screen.

CLEANING THE GRILLES

Keep the grilles free of obstructions and dust by cleaning them frequently with a regular vacuum cleaner or a brush. It is recommended to remove the front panel once a week following the instructions in the figure and to clean the filter with hot water and soap. Should a replacement be necessary, enter in contact with the builder to order spare parts.

PERIODS OF INACTIVITY

During inactivity periods, disconnect the electrical and hydraulic sources. Protect the equipment's external steel parts wiping them with a smooth cloth slightly damped with Vaseline oil. Leave the door ajar with the door stop in order to ensure correct air exchange.

For reactivation, before using:

- carry out an careful cleaning of the equipment and accessories;
- reconnect the equipment to the electrical and hydraulic sources;
- carry out an equipment inspection before reusing it;
- restart the equipment at low temperature for at least 60 minutes with no food inside.



To be sure that the equipment is maintained in perfect use and safety conditions, we recommend the execution of a maintenance and inspection service by an authorised assistance centre, at least once a year.

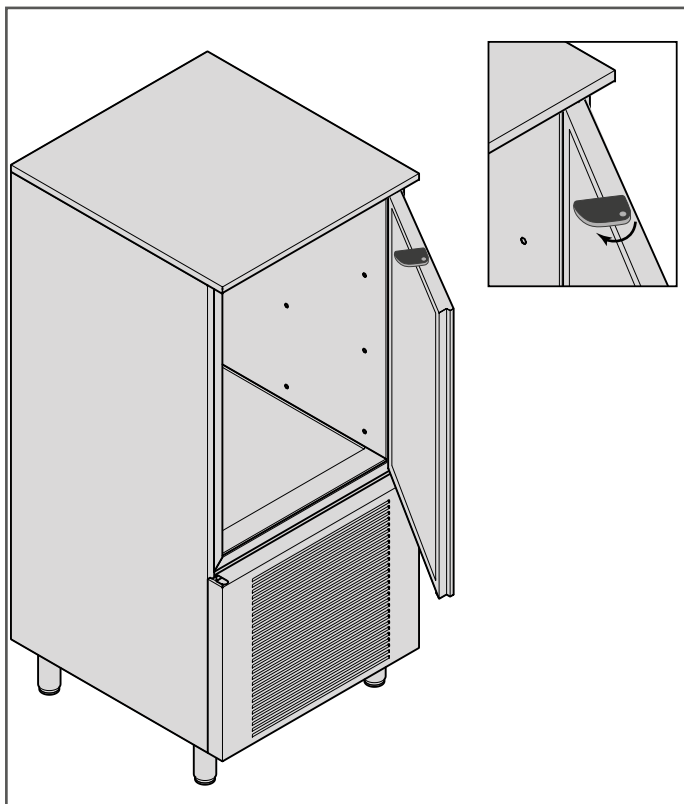
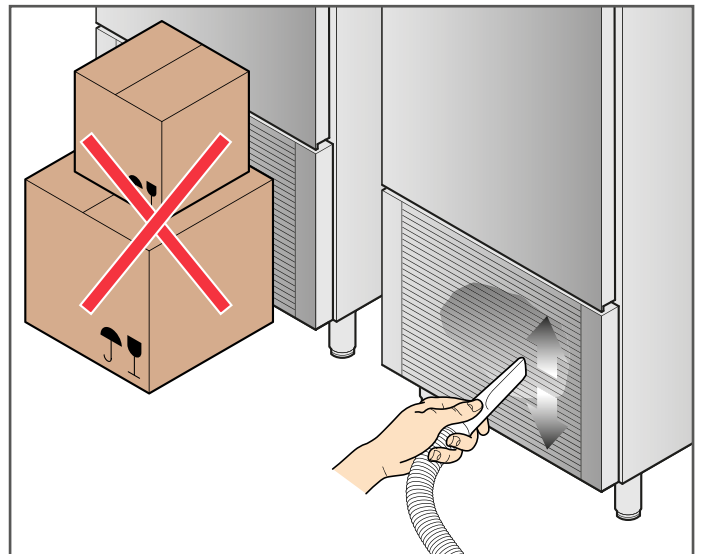

AFTER-SALES ASSISTANCE

If the equipment does not work or if functional or structural changes are noticed:

- disconnect it from the electrical and water sources;
 - consult the table below to check the proposed solutions;
- Should the solution not be present in the table, enter in contact with the assistance centre authorised by the manufacturer, communicating:
- the type of fault;
 - the code and the serial number of the equipment that can be found on its characteristics plate.

For repairs, use only original spare parts: the manufacturer declines any responsibility and does not grant the right of warranty when non-original spare parts are used.



To be sure that the equipment is maintained in perfect use and safety conditions, we recommend the execution of a maintenance and inspection service by an authorised assistance centre, at least once a year.

Manufacturer data:

F.R.C.
Via Treviso, 4 33083 - Taiedo di Chions (PN) - Italy
Tel. +39.0434.635411 - Fax. +39.0434.635414

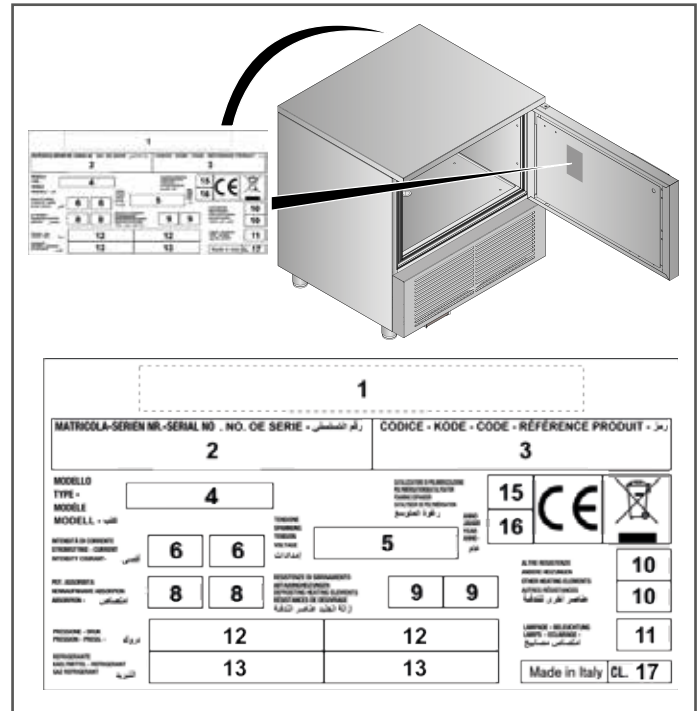

1	Manufacturer	10	Other elements
2	Serial number		nominal power
3	Code	11	Lamp power
4	Model	12	Minimum and
5	Voltage		maximum pressure
6	Running absorbed current	13	Refrigeration gas, type and quantity
8	Defrost heating element power	15	Insulation expanding gas
9	Defrost heating element power	16	Manufacture year
		17	Climatic class (#)

- # 4 = 32 °C 55% RH (IEC/EN 60335-2-89)
- # 5 = 43 °C 40% RH (IEC/EN 60335-2-89)
- # 4 = 30 °C 55% RH (EN 16825 / EN 17032)
- # 5 = 40 °C 40% RH (EN 16825 / EN 17032)

Type of problem	Before seeking contact with an assistance centre, check that...
The equipment is completely shut off.	- ...that electrical voltage is present on the equipment and that the plug was plugged into the socket.
The equipment does not chill sufficiently	- ...there is no effect of an external heat source; - ...the doors close perfectly; - ...the condenser filter is not clogged; - ...the front ventilation grilles are not obstructed by objects or dust; - ...the food is evenly distributed inside the cell and does not obstruct the ventilation inside the cell; - ...the equipment is not overloaded with food (comply with the equipment load indications affixed on it).
The equipment is very noisy	- ...there is no contact between the equipment any other object or machine; - ...the equipment is perfectly levelled; - ...the visible bolts are well tightened.



Do not try to repair the equipment by yourself, this may cause damage, even serious, to persons, animals and objects, and cause the voiding of the Warranty. Always look for an assistance centre authorised by the manufacturer and order ORIGINAL spare parts.

ALARMS

When there is an alarm in progress, it is signalled with a warning on the display.

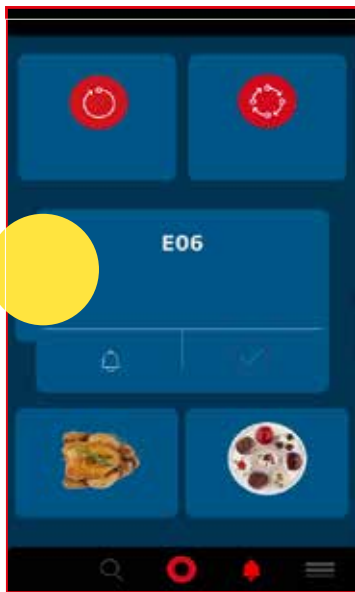

Chamber Probe Alarm (Contact technical assistance)

A probe failure causes a Chamber Probe Alarm and the buzzer and alarm relay are activated. The alarm signal occurs in the upper part of the display. The buzzer sounds, it can be silenced by tapping the display; at the end of the fault the alarm stops automatically and the alarm relay is deactivated.

However, with the Chamber Probe faulty, it is possible to start or continue a program of:

- **Timed Blast Chilling** (the Compressor is controlled on the Needle Probe).
- **Temperature Blast Chilling** not yet started switches to Time at Start.
- **Temperature Blast Chilling** in progress, it switches to Time if the Needle Probe is not inserted; the control of the Compressor takes place on the Needle Probe instead of the Cell Probe.
- **Temperature Blast Chilling** in progress with the Needle Probe inserted, turns the compressor on and off according to the pre-set times.

Evaporator Probe Alarm (Contact technical assistance)

A probe failure causes an Evaporator Probe Failure Alarm, the alarm is shown at the top of the display, the buzzer sounds, it can be silenced by tapping the display.

At the end of the fault, the alarm stops automatically and is deactivated.

High Temperature Alarm during preservation

During the positive or negative preservation phase, if the temperature remains above the determined set point, for a time defined by the parameter, a High Temperature Alarm is activated. The alarm is displayed at the top.

The buzzer sounds, it can be silenced by tapping the display. When the temperature falls below the alarm threshold, it stops automatically and deactivates. The alarm is stored in the HACCP log.

Low Temperature Alarm during preservation

During the positive or negative preservation phase, if the temperature remains below the determined set point, for a time defined by the parameter, a Low Temperature Alarm is activated. The alarm is displayed at the top.

The buzzer sounds, it can be silenced by tapping the display. When the temperature is above the alarm threshold, the alarm stops automatically and is deactivated. The alarm is stored in the HACCP log.

Needle Probe Alarm (Contact technical assistance)

A needle probe failure causes a Needle Probe fault alarm when it is in Stand-by or if a temperature-controlled blast chilling cycle is in progress (in this case the cycle automatically switches to time) or during needle cooking (in this case cooking ends). The alarm is shown at the top of the display, the buzzer can be silenced by tapping the display.

At the end of the fault, the alarm stops automatically and is deactivated. In the case of a Multipoint Needle, it is sufficient for a sensor to be in error to trigger the alarm.

Door Open Alarm

After a delay defined by a parameter, it causes the door open alarm, the compressor stops immediately and the alarm is shown at the top of the display. The buzzer sounds, it can be silenced by tapping the display, when the door is closed the alarm stops automatically.

ALARMS

HP pressure switch alarm (Contact technical assistance)

When the HP pressure switch alarm is detected by the board, the blast chilling cycles in progress end immediately. The compressor and evaporator fans are deactivated immediately, the alarm is shown at the top of the display.

The buzzer sounds, it can be silenced by tapping the display.

At the end of the fault, the alarm stops automatically.

LP pressure switch alarm (only for models that include it) (Contact technical assistance)

When the LP pressure switch alarm is detected by the board, the blast chilling cycles in progress end immediately. The compressor and evaporator fans are deactivated immediately, the alarm is shown at the top of the display.

The buzzer sounds, it can be silenced by tapping the display.

At the end of the fault, the alarm stops automatically.

Compressor thermal alarm (only for models that include it) (Contact technical assistance)

When the compressor thermal alarm is detected by the board, the blast chilling cycle in progress ends immediately.

The compressor and evaporator fans are deactivated, the alarm is shown at the top of the display.

The buzzer sounds, it can be silenced by tapping the display.

At the end of the fault, the alarm stops automatically.

Safety thermostat alarm (Contact technical assistance)

When the thermostat alarm is detected by the board, the blast chilling cycle in progress ends immediately.

The compressor, the fans, and the heating elements are immediately deactivated.

The alarm is shown at the top of the display.

The buzzer sounds, it can be silenced by tapping the display.

At the end of the fault, the alarm stops automatically.

Power failure alarm

When a power failure occurs during a cycle in progress, when the machine is restarted it restarts from the time of the phase at which it was.

The blast chilling time tolerance is 10 minutes.

The buzzer can be silenced by tapping the display.

DISPOSAL AND END OF SERVICE LIFE

The defrosting operations of the electrical and hydraulic circuits must be carried out exclusively by qualified technicians. If present, remove them and dispose them off in a correct manner:

- refrigeration gas;
- anti-freeze solutions present in the hydraulic circuits, avoiding spillage or losses in the environment.

According to art.13 of Legislative Decree no. 49 of 2014 "Application of Directive RAEE 2012/19/EU on residues of electrical and electronic equipment"



The mark with stripes on the stripped dumpster specifies that the product was placed on the market after August 13, 2015, and that, at the end of its service life, must not be mixed with other residues, but disposed off separately.

The whole equipment was built with recyclable metallic materials (stainless steel, iron, aluminium, zinc-coated plates, copper, etc.) in percentage above 90% of the weight.

Render the equipment unusable when disposing off by removing the power source cable and any other device that closes the compartments or cavities (where present).

Care must be taken in the management of this product at the end of its service life, to mitigate negative impacts on the environment and improve the effectiveness of the use of resources, applying the principles of "who pollutes pays", prevention, preparation for re-utilisation, recycling and recovery.

We remind that the uncontrolled or incorrect disposal of the product is liable to the application of the sanctions foreseen in the present legal standards.

Information about disposal in Italy

In Italy, RAEE equipment must be delivered to:

- Collection Centres (also known as ecological islands or ecological platforms)
- the dealers in which new equipment can be purchased, which are requested to collect it free of charge (collection "one for one");

Information about disposal in the European Union nations

The community Directive on RAEE equipment was accepted in different ways by each nation, therefore, if this equipment must be disposed off, we suggest a contact with the local authorities or the Dealers about the correct disposal method.



While waiting for demolition or disposal, the equipment can be temporarily stored, also in open air, because the unit has its electrical, refrigeration and hydraulic circuits integrated and closed. However, make sure that the doors cannot be closed to avoid entrapment.

The laws in force in the user's country concerning environment protection must also be observed.

WARRANTY

The manufacturer's obligation regarding the warranty that covers the equipment and other parts produced by it is valid for a period of 1 year as of the invoice date, and consists of the supply free of charge of parts that must be replaced that, at its own discretion, are considered defective.

It will be the manufacturer's duty to solve eventual faults and defects, provided the equipment is correctly installed and operated in accordance with the instructions contained in the manual. Any damage arising from limescale build-up, over voltage or tampering by unauthorised or unqualified personnel will void the warranty.

Consumption components such as glass, aesthetic parts, seals, lamps and parts that subject to wear after utilisation, are excluded from the warranty.

During the warranty period, the expenses concerning providing of services, travels or transfers, transport of parts and eventual replacement equipment are borne by the purchaser.

The materials replaced under warranty will remain of our property and must be returned at the purchaser's care and expense.

F.R.C.

Via Treviso, 4 33083 - Taiedo di Chions (PN) - Italia

Tel. +39.0434.635411 - Fax. +39.0434.635414